



LG02/OLG02 LoRa Gateway User Manual

Document Version: 1.5.2

Firmware Version: LG02_LG08--build-v5.3.1581838658-20200216-1539

Version	Description	Date
1.0	Release	2018-Sep-11
1.1	Enrich content for ABP	2018-Oct-07
1.2	Add TCP_IP Client Instruction, Add Radiohead support (firmware ver > LG02_LG08--build-v5.1.1541419802-20181105-2011)	2018-Nov-5
1.3	Add notice for recover mode, add packet relay mode example. Add Example for LoRa RAW. Add Manual for MQTT mode (firmware ver > LG02_LG08--build-v5.1.1545026772-20181217-1407)	2018-Dec-27
1.4	Add Customized Script Feature (firmware ver > LG02_LG08--build-v5.1.1547896817-20190119-1921)	2019-Jan-19
1.5	-Add Downlink support and example. (firmware ver > LG02_LG08--build-v5.1.1548820215-20190130-1151) -Correct typo for the UNO code of example for lg02_single_rx_tx	2019-Jan-30
1.5.1	Add How to control LEDs, add hardware source, improve limitation description.	2019-May-13
1.5.2	Relay mode limitation, MQTT instruction	2019-Jun-19
1.5.3	Add photo for OLG02 SIM card installation	2019-Nov-01
1.5.4	--Change the HTTP Port and SSH port for firmware version > v5.3	2019-Nov-26

1.6.0	-- Add more features, remote access	2020-Mar-02
-------	-------------------------------------	-------------

1. Introduction.....	6
1.1 What is LG02 & OLG02.....	6
1.2 Specifications.....	7
1.3 Features.....	9
1.4 System Structure	9
1.5 Applications.....	10
1.6 Hardware Variants	11
1.7 Install SIM card in 4G module.....	12
1.8 Firmware Change log	12
2. Access LG02	13
3. Typical Network Setup	14
3.1 Overview	14
3.2 Use WAN port to access Internet.....	14
3.3 Access Internet as a WiFi Client.....	15
3.4 Use built-in 4G modem for internet access	17
3.5 Check Internet connection.....	19
4. Example 1: Configure as a LoRaWAN gateway – LoRaWAN mode	20
4.1 Create a gateway in TTN Server.....	20
4.2 Configure LG02 Gateway.....	22
4.2.1 Configure to connect to LoRaWAN server	22
4.2.2 Configure LG02's RX frequency.....	23
4.3 Create LoRa End Node.....	24
4.3.1 About Limited support for LoRaWAN	24
4.3.2 Preparation	25
4.3.3 Test with OTAA LoRa end node (LoRa Shield + UNO).....	26
4.3.4 Test with ABP LoRa end node (LoRa Shield + UNO)	30
5. Example 2: Control LoRa radio directly as general LoRa transceiver	34
5.1 User LoRa Radio via pkt_fwd.....	34
5.1.1 Use pkt_fwd to receive.....	34
5.1.2 Use pkt_fwd to transmit	34
5.2 Use LoRa radio device directly.....	36

6.	Example 3: MQTT Transfer Mode	39
7.	Example 4: TCP IP Client Mode	40
8.	Example 5: Write a customized script	42
9.	Example 6: LoRaWAN Packet Relay mode	44
9.1	<i>How it works</i>	44
9.2	<i>Limitation</i>	46
10.	More features	47
10.1	<i>Remote Access</i>	47
10.2	<i>More instructions</i>	47
11.	Linux System	47
11.1	<i>SSH Access for Linux console</i>	47
11.2	<i>Edit and Transfer files</i>	49
11.3	<i>File System</i>	49
11.4	<i>Package maintain system</i>	51
12.	Upgrade Linux Firmware	52
12.1	<i>Upgrade via Web UI</i>	52
12.2	<i>Upgrade via Linux console</i>	52
13.	FAQ	53
13.1	<i>Why there is 433/868/915 version LoRa part?</i>	53
13.2	<i>What is the frequency range of LG02 LoRa part?</i>	53
13.3	<i>What does "Limited support on LoRaWAN"?</i>	53
13.4	<i>Can I develop my own application for LG02?</i>	55
13.5	<i>Can I make my own firmware for LG02? Where can I find the source code of LG02?</i>	55
13.6	<i>Can I change the LoRa behavior of LG02?</i>	55
13.7	<i>On OTAA mode, if I use the other frequency, how should I modify in the library?</i>	55
13.8	<i>How can I reset the device to factory default?</i>	56
13.9	<i>Can I control the LEDs?</i>	57
14.	Trouble Shooting	58
14.1	<i>I get kernel error when install new package, how to fix?</i>	58

14.2	<i>How to recover the LG02 if firmware crash</i>	<i>59</i>
14.3	<i>I configured LG02 for WiFi access and lost its IP. What to do now?.....</i>	<i>60</i>
15.	Order Info	61
16.	Packing Info	61
17.	Support.....	61
18.	Reference.....	63

1. Introduction

1.1 What is LG02 & OLG02

LG02 & OLG02 are an open source dual channels LoRa Gateway. It lets you bridge LoRa wireless network to an IP network via WiFi, Ethernet, 3G or 4G cellular. The LoRa wireless allows users to send data and reach extremely long ranges at low data-rates. It provides ultra-long range spread spectrum communication and high interference immunity.

LG02 & OLG02 have rich internet connection method such as WiFi interface, Ethernet port and USB host port. These Interfaces provide flexible methods for users to connect their sensor networks to Internet.

LG02 & OLG02 can support the LoRaWAN protocol in single frequency and customized LoRa transition protocol. The design of LG02 is use the Linux to directly control two sx1276/sx1278 LoRa modules which lets the LoRa can works in full duplex LoRa mode and increase the communication efficiency.

LG02 can be used to provide a low cost IoT wireless solution to support 50~300 sensor nodes.

Except LoRaWAN mode, LG02 can support multiply working mode such as: [LoRa repeater mode](#), [MQTT mode](#), [TCP/IP Client mode](#), [TCP/IP Server mode](#) to fit different requirement for IoT connection. Click this link for more info about the modes.

LG02 & OLG02 provide a low cost for your IoT network connection. Compare to the cost with normal SX1301 LoRaWAN solution. LG02 & OLG02 is only of its 1/4 or less cost. This makes the LG02 very suitable to set up small scale LoRa network or use it to extend the coverage of current LoRaWAN network.

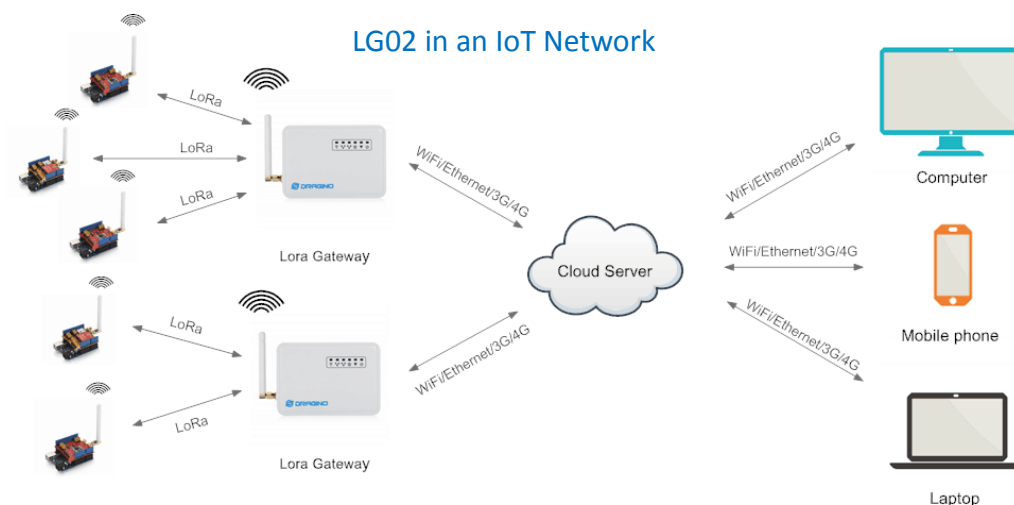

1.2 Specifications

Hardware System:

Linux Part:

- 400Mhz ar9331 processor
- 64MB RAM
- 16MB Flash

Interface:

- 10M/100M RJ45 Ports x 2
- WiFi : 802.11 b/g/n
- LoRa Wireless
- Power Input: 12V DC
- USB 2.0 host connector x 1
- USB 2.0 host internal interface x 1
- 2 x LoRa Interfaces

WiFi Spec:

- IEEE 802.11 b/g/n
- Frequency Band: 2.4 ~ 2.462GHz
- Tx power:
 - ✓ 11n tx power : mcs7/15: 11db mcs0 : 17db
 - ✓ 11b tx power: 18db
 - ✓ 11g 54M tx power: 12db
 - ✓ 11g 6M tx power: 18db
- Wifi Sensitivity
 - ✓ 11g 54M : -71dbm
 - ✓ 11n 20M : -67dbm

LoRa Spec:

- Frequency Range:
 - ✓ Band 1 (HF): 862 ~ 1020 Mhz
 - ✓ Band 2 (LF): 410 ~ 528 Mhz
- 168 dB maximum link budget.
- +20 dBm - 100 mW constant RF output vs.
- +14 dBm high efficiency PA.
- Programmable bit rate up to 300 kbps.
- High sensitivity: down to -148 dBm.
- Bullet-proof front end: IIP3 = -12.5 dBm.
- Excellent blocking immunity.
- Low RX current of 10.3 mA, 200 nA register retention.
- Fully integrated synthesizer with a resolution of 61 Hz.
- FSK, GFSK, MSK, GMSK, LoRaTM and OOK modulation.
- Built-in bit synchronizer for clock recovery.

- Preamble detection.
- 127 dB Dynamic Range RSSI.
- Automatic RF Sense and CAD with ultra-fast AFC.
- Packet engine up to 256 bytes with CRC.
- Built-in temperature sensor and low battery indicator.

Cellular 4G LTE (optional):

- Quectel [EC25 LTE module](#)
- Micro SIM Slot
- Internal 4G Antenna + External 4G Sticker Antenna.
- Up to 150Mbps downlink and 50Mbps uplink data rates
- Worldwide LTE,UMTS/HSPA+ and GSM/GPRS/EDGE coverage
- MIMO technology meets demands for data rate and link reliability in modem wireless communication systems

1.3 Features

- ✓ Open Source OpenWrt LEDE system
- ✓ Low power consumption
- ✓ Firmware upgrade via Web
- ✓ Software upgradable via network
- ✓ Flexible protocol to connect to IoT servers
- ✓ Auto-Provisioning
- ✓ Built-in web server
- ✓ Managed by Web GUI, SSH via LAN or WiFi
- ✓ Internet connection via LAN, WiFi, 3G or 4G
- ✓ Failsafe design provides robustly system
- ✓ 2 x SX1276/SX1278 LoRa modules
- ✓ Full - duplex LoRa transceiver
- ✓ Two receive channels, and one transmit channel
- ✓ Limited support in LoRaWAN/ Support Private LoRa protocol
- ✓ Support upto 300 nodes
- ✓ LoRa band available at 433/868/915/920 Mhz
- ✓ Max range in LoRa: 5~10 km. Density Area:>500m

1.4 System Structure

LG02 System Overview:

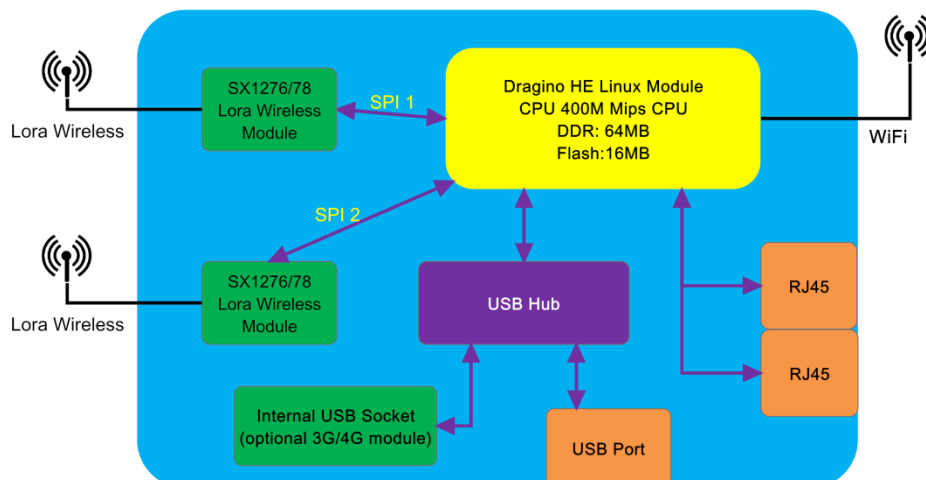



1.5 Applications

Dragino Lora Gateway for IoT Applications



1.6 Hardware Variants

The LG02 and OLG02 use the same firmware and have the same feature in the software side. In this document, we will use LG02 as the model number to explain the feature.

Model	Photo	Description
LG02		Indoor version for dual channel LoRa Gateway, without 4G module
LG02		Indoor version for dual channel LoRa Gateway, include 4G module.
OLG02		Outdoor version for dual channel LoRa Gateway

1.7 Install SIM card in 4G module

For LG02 & OLG02 4G version, the 4G module is inside the box, please open the box and use below direction to install the SIM card

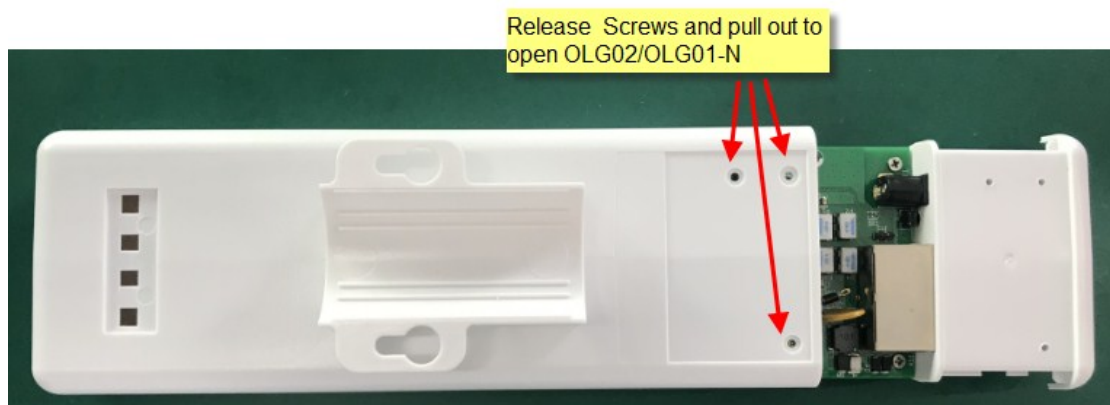
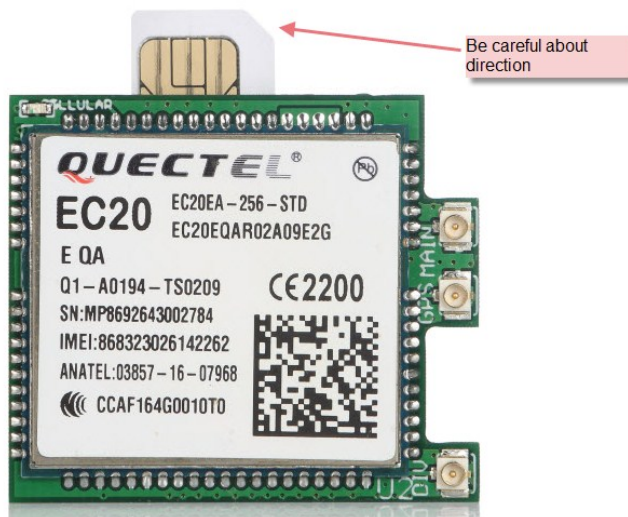

1.8 Firmware Change log

Please see this link for firmware change log:

http://www.dragino.com/downloads/index.php?dir=LoRa_Gateway/LG02-OLG02/Firmware/&file=ChangeLog

2. Access LG02

Access and configure LG02

The LG02 is configured as a WiFi AP by factory default. User can access and configure the LG02 after connect to its WiFi network.

At the first boot of LG02, it will auto generate an unsecure WiFi network call dragino-xxxxxx

User can use the laptop to connect to this WiFi network. The laptop will get an IP address 10.130.1.xxx and the LG01 has the default IP 10.130.1.1



Open a browser in the laptop and type

<http://10.130.1.1/cgi-bin/luci/admin>

User will see the login interface of LG02.

The account for Web Login is:

User Name: root

Password: dragino

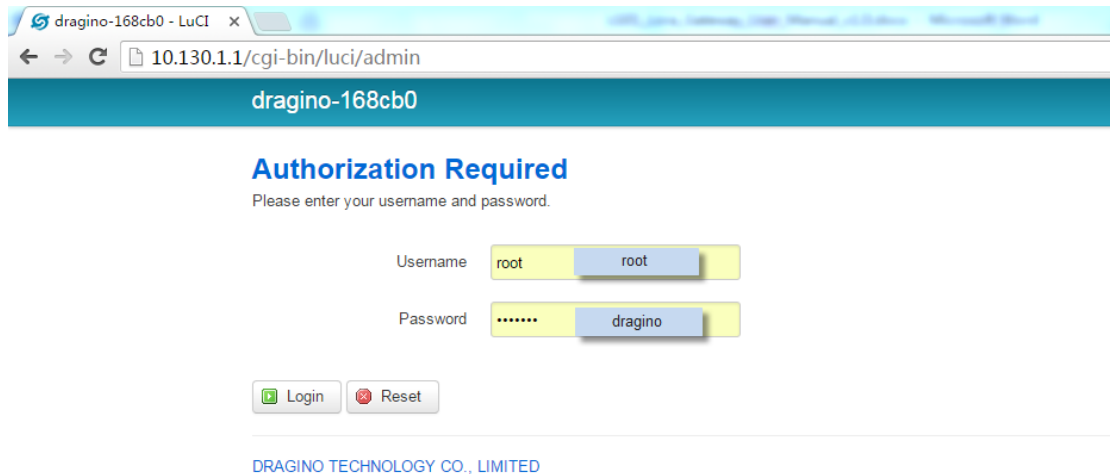

Notice: In case the WiFi network is disabled, user can connect the PC to LG02's LAN port, the PC will get DHCP from LG02, and be able to access it.

Note: the LG02 can also be accessed via WAN interface (WAN port or WiFi when device acts as WiFi Client). But for security reason, for firmware version >5.3, the http access on WAN interface has been set to 8000, SSH access has been set to 2222.

3. Typical Network Setup

3.1 Overview

LG02 supports flexible network set up for different environment. This section describes the typical network topology can be set in LG02. The typical network set up includes:

- ✓ WAN Port Internet Mode
- ✓ WiFi Client Mode
- ✓ WiFi AP Mode
- ✓ USB Dial Up Mode

3.2 Use WAN port to access Internet

By default, the LG02 set to use WAN port as network connection. When connect LG02's WAN port to router, LG02 will get IP from router and have internet access. The network status can be checked as below:

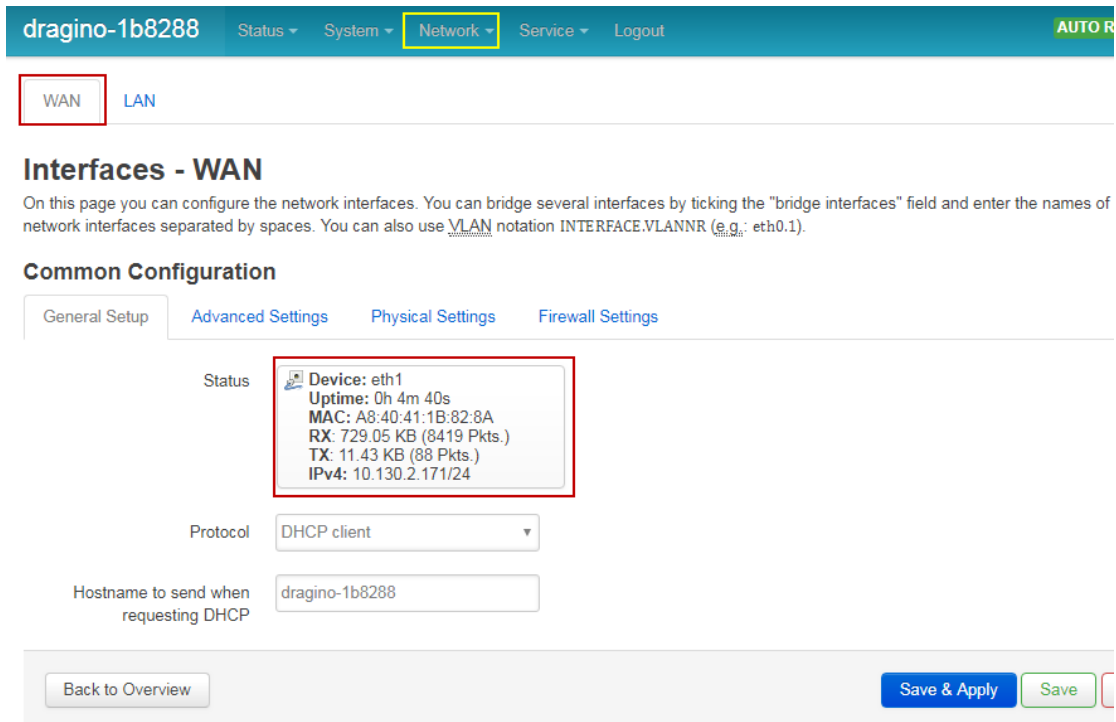

dragino-1b8288 Status System **Network** Service Logout AUTO R

WAN LAN

Interfaces - WAN

On this page you can configure the network interfaces. You can bridge several interfaces by ticking the "bridge interfaces" field and enter the names of network interfaces separated by spaces. You can also use VLAN notation INTERFACE.VLANNR (e.g.: eth0.1).

Common Configuration

General Setup **Advanced Settings** Physical Settings Firewall Settings

Status  Device: eth1
Uptime: 0h 4m 40s
MAC: A8:40:41:1B:82:8A
RX: 729.05 KB (8419 Pkts.)
TX: 11.43 KB (88 Pkts.)
IPv4: 10.130.2.171/24

Protocol DHCP client

Hostname to send when requesting DHCP dragino-1b8288

Back to Overview Save & Apply Save

3.3 Access Internet as a WiFi Client.

In the WiFi Client Mode, Dragino acts as a WiFi client and gets DHCP from uplink router via WiFi. The step to set is as below:

Step1:

In network -> Wireless, select Radio0 interface and scan.

The screenshot shows the 'Wireless Overview' section for the 'radio0' interface. It displays the MAC address 'Generic MAC80211 802.11bgn', channel '11 (2.462 GHz)', and bitrate '? Mbit/s'. There are buttons for 'Restart', 'Scan' (circled in red), and 'Add'. Below this, it shows the SSID 'dragino-1b8288', Mode 'Master', BSSID 'A8:40:41:1B:82:88', and Encryption 'None'. There are also buttons for 'Disable', 'Edit', and 'Remove'.

Step2:

Select the wireless AP and join:

The screenshot shows the 'Join Network: Wireless Scan' section. It contains a table with columns: Signal, SSID, Channel, Mode, BSSID, and Encryption. Two networks are listed: 'dragino-office' (100% signal) and 'ChinaNet-gLnb' (84% signal). The 'Join Network' button for 'dragino-office' is circled in red.

Signal	SSID	Channel	Mode	BSSID	Encryption	
100%	dragino-office	8	Master	50:64:2B:1A:B8:4D	mixed WPA/WPA2 - PSK	Join Network
84%	ChinaNet-gLnb	2	Master	A4:29:40:66:F4:E7	mixed WPA/WPA2 - PSK	Join Network

The screenshot shows the 'Joining Network: "dragino-office"' configuration page. It includes a checkbox for 'Replace wireless configuration' and a note to check this option to delete existing networks. The 'WPA passphrase' field is circled in red. Below it, there is a field for 'Name of the new network' (value: wwan) and a dropdown for 'Create / Assign firewall-zone' (value: wan: wan:). A 'Submit' button is circled in red at the bottom right.

Step3:

In network->wireless page, disable WiFi AP network. Notice: After doing that, you will lose connection if your computer connect to the LG02 via LG02's wifi network.

radio0: Master "dragino-1b8288"

Wireless Overview

	Generic MAC80211 802.11bgn Channel: 11 (2.462 GHz) Bitrate: ? Mbit/s	Restart	Scan	Add
	SSID: dragino-1b8288 Mode: Master BSSID: A8:40:41:1B:82:88 Encryption: None	Disable	Edit	Remove
	SSID: dragino-office Mode: Client BSSID: 50:64:2B:1A:B8:4D Encryption: -	Disable	Edit	Remove

Associated Stations

Network	MAC-Address	Host	Signal / Noise	RX Rate / TX Rate
---------	-------------	------	----------------	-------------------

No information available

After successful associate, the WiFi network interface can be seen in the same page:

WAN WWAN LAN

Interfaces

LAN 	Protocol: Static address Uptime: 2h 0m 4s MAC: A8:40:41:1B:82:8B RX: 1.40 MB (13346 Pkts.) TX: 2.79 MB (10321 Pkts.) IPv4: 10.130.1.1/24	Restart	Stop	Edit	Delete
WAN 	Protocol: DHCP client MAC: A8:40:41:1B:82:8A RX: 4.30 MB (51840 Pkts.) TX: 55.77 KB (429 Pkts.)	Restart	Stop	Edit	Delete
WWAN 	Protocol: DHCP client Uptime: 0h 6m 6s MAC: A8:40:41:1B:82:88 RX: 549.38 KB (5659 Pkts.) TX: 14.90 KB (94 Pkts.) IPv4: 10.130.2.169/24	Restart	Stop	Edit	Delete

Add new interface...

Save & Apply Save Reset

3.4 Use built-in 4G modem for internet access

For the LG02 model with 4G version, user can configure the modem for internet access.

Step 1: Add New Interface

The screenshot shows the 'Network' configuration page for a device named 'dragino-1b8288'. The 'Network' menu item is highlighted in the top navigation bar. Below the navigation, there are tabs for 'WAN', 'WWAN', and 'LAN'. The main area is titled 'Interfaces' and lists three existing interfaces: LAN (br-lan), WAN (eth1), and WWAN (Client "dragino-office"). Each interface card shows its protocol, MAC address, and traffic statistics. At the bottom of the interface list, there is a button labeled 'Add new interface...' which is circled in red. A yellow callout box with the text 'Add New Interface' has a red arrow pointing to this button. At the bottom right of the interface list, there are buttons for 'Save & Apply', 'Save', and 'Reset'.

The screenshot shows the 'Create Interface' form. The 'Name of the new interface' field contains 'Cellular'. Below this field, a note states: 'The allowed characters are: A-Z, a-z, 0-9 and _'. Another note below that states: 'Maximum length of the name is 15 characters including the automatic protocol/bridge prefix (br-, gin4-, pppoe- etc.)'. The 'Protocol of the new interface' dropdown menu is set to 'UMTS/GPRS/EV-DO' and is circled in red. A yellow callout box with the text 'Choose UMTS/GPRS/EV-DO' has a red arrow pointing to this dropdown. At the bottom of the form, there are 'Cancel' and 'Submit' buttons.

Step 2: Configure cellular interface

dragino-1b8288 Status System Network Service Logout **UNSAVED C**

Interfaces - CELLULAR

On this page you can configure the network interfaces. You can bridge several interfaces by ticking the "bridge interfaces" field and network interfaces separated by spaces. You can also use VLAN notation INTERFACE.VLANNR (e.g.: eth0.1).

Common Configuration

General Setup **Advanced Settings** Firewall Settings

Status  Device: 3g-Cellular
RX: 0 B (0 Pkts.)
TX: 0 B (0 Pkts.)

Protocol UMTS/GPRS/EV-DO

Modem device **Use ttyUSB2 to dial up**

Service Type **Different provider has different APN**

APN **Different provider has different APN**

PIN

PAP/CHAP username **Some provider may need additional user info**

PAP/CHAP password **Some provider may need additional user info**

Dial number

Step 3: Check Result

dragino-1b8288 Status System Network Service Logout **AUTO REFRESH ON**

WAN WWAN **CELLULAR** LAN

Interfaces

CELLULAR
3g-Cellular

Protocol: UMTS/GPRS/EV-DO
Uptime: 0h 0m 49s
MAC: 00:00:00:00:00:00
RX: 116 B (6 Pkts.)
TX: 680 B (16 Pkts.)
IPv4: 10.160.169.29/32 **Get IP from provider means dial up**

Restart Stop **Edit** Delete

Note: In case you don't know if your device has 4G modem, you can run lsusb command in SSH access to check, as below:

10.130.1.1 - SecureCRT

文件(F) 编辑(E) 查看(V) 选项(O) 传输(T) 脚本(S) 工具(L) 帮助(H)

10.130.1.1

```
root@dragino-1b8288:~# lsusb
```

use lsusb command

```
Bus 001 Device 003: ID 2c7c:0125
Bus 001 Device 002: ID 1a40:0101 Terminus Technology, Inc. Hub
Bus 001 Device 001: ID 1d6b:0002 Linux Foundation 2.0 USB Device
root@dragino-1b8288:~#
```

This is the 4G modem

3.5 Check Internet connection

User can use the diagnostics page to check and analyze Internet connection.

dragino-1b8288 Status ▾ System ▾ **Network ▾** Service ▾ Logout

Diagnostics

Network Utilities

openwrt.org openwrt.org openwrt.org

IPv4 ▾ **Ping** **Traceroute** **Nslookup**

Install iputils-traceroute6 for IPv6 traceroute

```
PING openwrt.org (139.59.209.225): 56 data bytes
64 bytes from 139.59.209.225: seq=0 ttl=45 time=386.898 ms
64 bytes from 139.59.209.225: seq=1 ttl=45 time=401.656 ms
64 bytes from 139.59.209.225: seq=2 ttl=45 time=387.708 ms
64 bytes from 139.59.209.225: seq=3 ttl=45 time=378.894 ms
64 bytes from 139.59.209.225: seq=4 ttl=45 time=384.156 ms

--- openwrt.org ping statistics ---
5 packets transmitted, 5 packets received, 0% packet loss
round-trip min/avg/max = 378.894/387.862/401.656 ms
```

4. Example 1: Configure as a LoRaWAN gateway – LoRaWAN mode

LG02 has two LoRa channels and can be configured as a Dual Channel LoRaWAN gateway. LG02 is pre-configured to support one uplink channel and one downlink channel in the LoRaWAN mode.

This mode works as below diagram:

LoRaWAN mode:

Use LG02 / OLG02 as a [LoRaWAN gateway*](#) to forward packet to LoRaWAN IoT Server

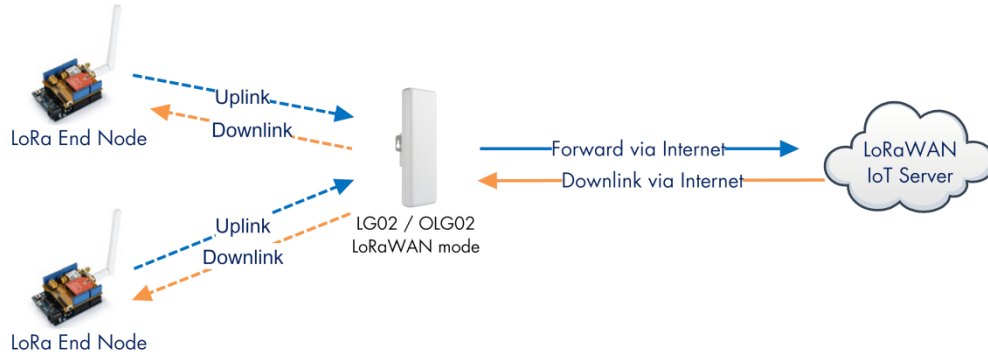

Operate Principle:

- > LG02/OLG02 running packet forward and will forward the uplink LoRa packet from end node to LoRaWAN server.
- > It will also forward downlink LoRa packet from LoRaWAN server to end node.
- > The end node can use OTAA or ABP mode in the LoRaWAN protocol.

Limitation:

- > The LG02 only support one LoRaWAN frequency for uplink. So the end node should be set to fix frequency.
- > If end node use multiply frequencies to transfer, The LG02 will only be able to receive the same frequency set in LG02.

This chapter describes how to use LG02 to work with [TTN LoRaWAN Server](#). The method to work with other LoRaWAN is similar.

4.1 Create a gateway in TTN Server

Step 1: Get a Unique gateway ID.

Every LG02 has a unique gateway id. The id can be found at LoRaWAN page:

dragino-1b6fc4
Status ▾ System ▾ Network ▾ Service ▾ Logout

LoRa Gateway Settings

Configuration to communicate with LoRa devices and LoRaWAN server

LoRaWAN Server Settings

Service Provider	<input type="text" value="The Things Network"/>
Server Address	<input type="text" value="ttn-router-eu"/>
Server Port	<input type="text" value="1700"/>
Gateway ID	<input style="border: 2px solid red;" type="text" value="a840411b6fc44150"/>
Mail Address	<input type="text" value="dragino-1b6fc4@dragino.com"/>
Latitude	<input type="text" value="22.73"/>
Longitude	<input type="text" value="114.23"/>
RadioMode	<input type="text" value="A for RX, B for TX"/>

The gateway id is: **a840411b6fc44150**

Step 2: Sign up a user account in TTN server

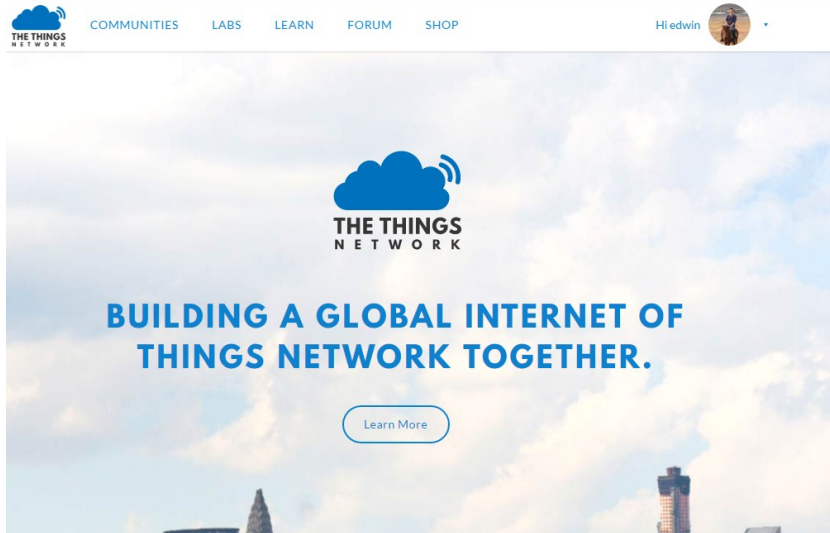

Step 3: Create a Gateway in TTN

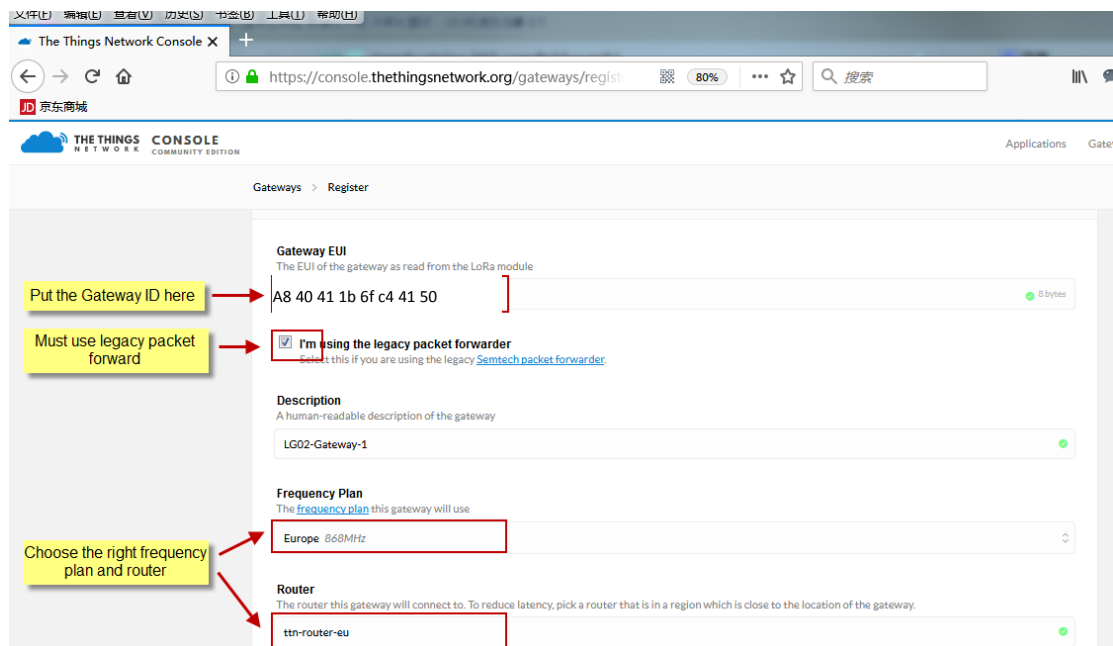
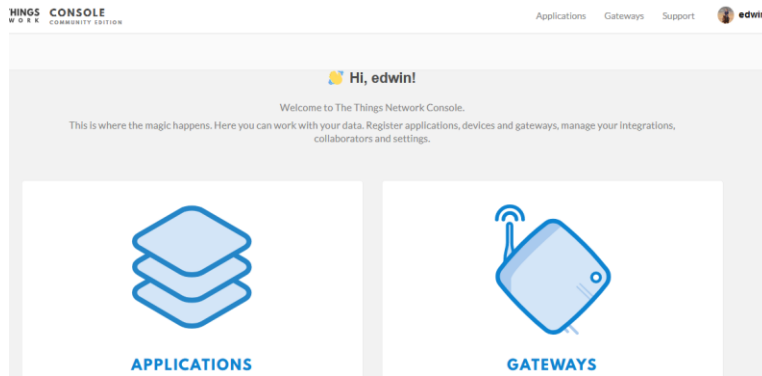

After create the gateway, we can see the gateway info, as below, the **Status** shows “not connected” because the LG02 doesn’t configure to send update status yet.

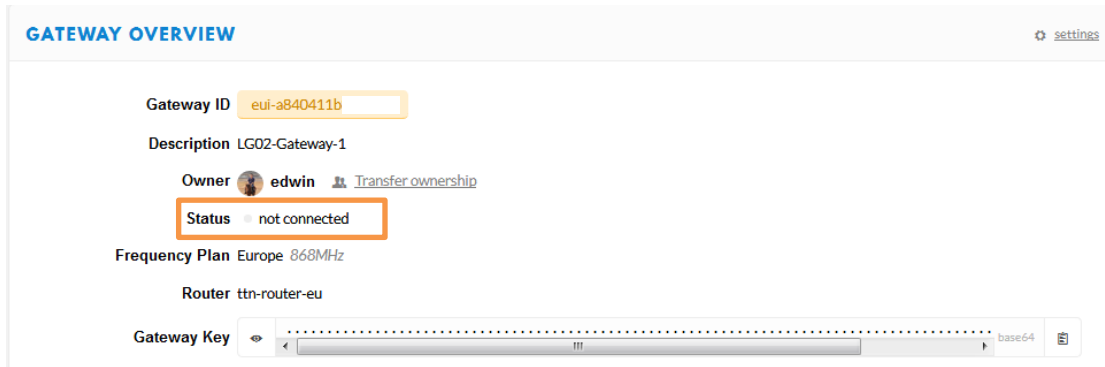

4.2 Configure LG02 Gateway

4.2.1 Configure to connect to LoRaWAN server

We should configure the LG02 now to let it connect to TTN network. Make sure your LG02 has Internet Connection first.

Step1: Configure LG02 to act as raw forwarder

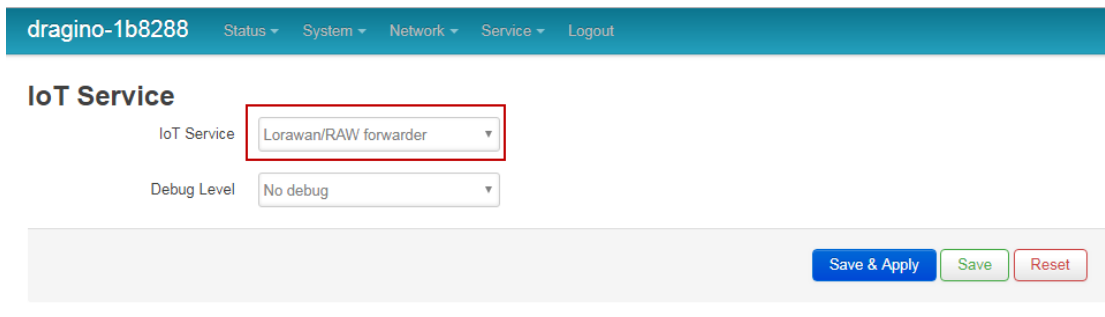

DRAGINO TECHNOLOGY CO., LIMITED

Step2: Input server info and gateway id

Choose the correct the server address and gateway ID.

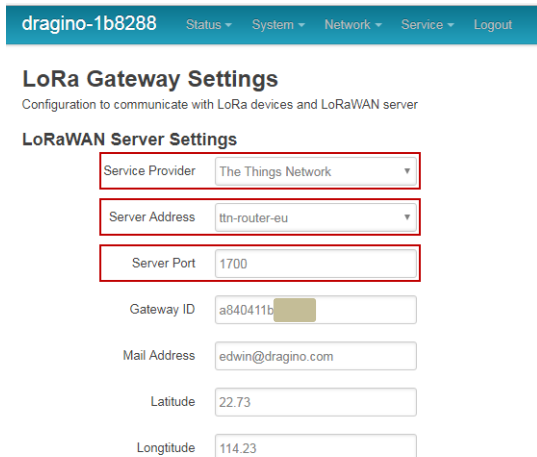

Check Result

After above settings, the LG02 should be able to connect to TTN, below is the result seen from TTN:

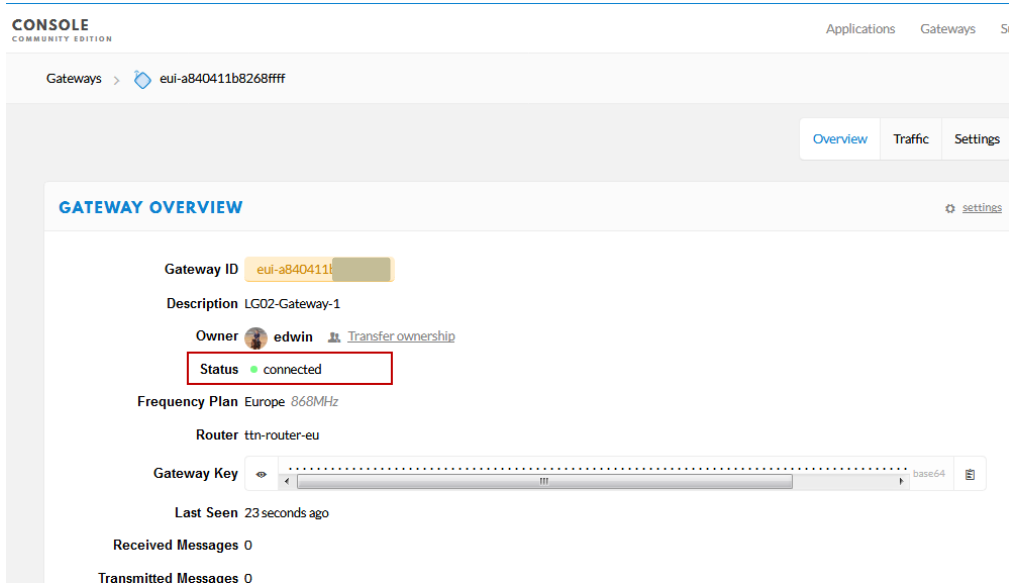

4.2.2 Configure LG02's RX frequency

Now we should configure LG02 to act receive the LoRaWAN packets. This is in Channel 1, we configure is to use 868.1Mhz (868100000 Hz) as below.

Channel 1 Radio Settings

Radio settings for Channel 1

RX Frequency (Unit:Hz)	868100000
RX Spreading Factor	SF7
TX Frequency (Unit:Hz)	868100000
TX Spreading Factor	SF9
Coding Rate	4/5
Signal Bandwidth	125 kHz
Preamble Length	8
Length range: 6 ~ 65536	
Encryption Key	Encryption Key

Users only need to configure the RX Radio settings. In LoRaWAN protocol, the downlink packet from LoRaWAN server will specify the downlink frequency and SF (Spreading Factor), the gateway will use these parameters to send out Downlink LoRaWAN packets.

4.3 Create LoRa End Node

4.3.1 About Limited support for LoRaWAN

LG02 supports LoRaWAN End Node, in LoRaWAN protocol, it requires LoRaWAN node to send data in a hopping frequency. Since LG02 only support one single frequency, it will only able to receive the packet which is of the same Radio Frequency set up in LG02 Radio 1.

For example, in EU868, a standard LoRaWAN device may send the data in eight frequencies with different SF, such as:

```
LMIC_setupChannel(0, 868100000, DR_RANGE_MAP(DR_SF12, DR_SF7), BAND_CENTI); // g-band
LMIC_setupChannel(1, 868300000, DR_RANGE_MAP(DR_SF12, DR_SF7B), BAND_CENTI); // g-band
LMIC_setupChannel(2, 868500000, DR_RANGE_MAP(DR_SF12, DR_SF7), BAND_CENTI); // g-band
LMIC_setupChannel(3, 867100000, DR_RANGE_MAP(DR_SF12, DR_SF7), BAND_CENTI); // g-band
LMIC_setupChannel(4, 867300000, DR_RANGE_MAP(DR_SF12, DR_SF7), BAND_CENTI); // g-band
LMIC_setupChannel(5, 867500000, DR_RANGE_MAP(DR_SF12, DR_SF7), BAND_CENTI); // g-band
LMIC_setupChannel(6, 867700000, DR_RANGE_MAP(DR_SF12, DR_SF7), BAND_CENTI); // g-band
LMIC_setupChannel(7, 867900000, DR_RANGE_MAP(DR_SF12, DR_SF7), BAND_CENTI); // g-band
LMIC_setupChannel(8, 868800000, DR_RANGE_MAP(DR_FSK, DR_FSK), BAND_MILLI); // g2-band
```

So the LG02 will only able to receive the 868100000, SF7 packet and will not receive others. Means only one packet will arrive the TTN server in every 8 packet sent from the LoRaWAN end node.

If user want all the packets from LoRaWAN end device can arrive LoRaWAN server, user need to set up the LoRaWAN node to send packet in a specify frequency.

In this section, we will use LoRa Shield and a modify LMIC Library to show how to configure LoRaWAN end node and let's work in single frequency.

4.3.2 Preparation

LoRaWAN End device Hardware:

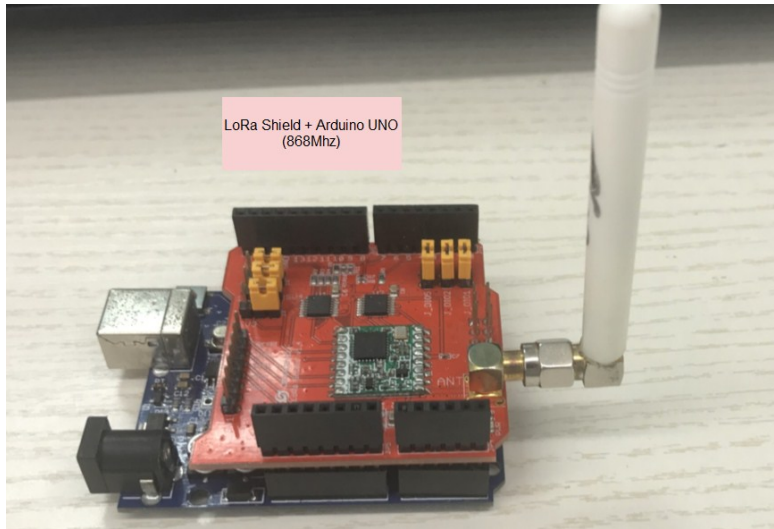

Software Library for LoRaWAN End device:

Install this library <https://github.com/dragino/arduino-lmic> to the Arduino Library path. Before compiling the End Device software, User needs to change the Frequency Band to use with LG02. What user need to change is in the file `arduino\libraries\arduino-lmic\src\lmic\config.h`.

Changes are as below:

```

#define CFG_eu868 1
// #define CFG_us915 1
// #define CFG_as923 1
// #define CFG_in866 1

#define LG02_LG01 1

//US915: DR_SF10=0, DR_SF9=1, DR_SF8=2, DR_SF7=3, DR_SF8C=4
// DR_SF12CR=8, DR_SF11CR=9, DR_SF10CR=10, DR_SF9CR=11, DR_SF8CR=12, DR_SF7CR
#if defined(CFG_us915) && defined(LG02_LG01)
// CFG_us915 || CFG_as923
#define LG02_UPFREQ 902320000
#define LG02_DNWFREQ 923300000
#define LG02_RXSF 3 // DR_SF7
#define LG02_TXSF 8 // DR_SF12CR
#else
//EU868: DR_SF12=0, DR_SF11=1, DR_SF10=2, DR_SF9=3, DR_SF8=4, DR_SF7=5, DR_SF7B=1, DR_FSK, DR_NONE
#define LG02_UPFREQ 868100000
#define LG02_DNWFREQ 869525000
#define LG02_RXSF 5 // DR_SF7
#define LG02_TXSF 0 // DR_SF12
#endif

```

Choose the Frequency Band, same as in LoRaWAN server

uncomment this for LG01 / LG02

LG02_UPFREQ: End Device Uplink Frequency
 LG02_DNWFREQ: End Device Uplink Frequency
 LG02_RXSF: End Device Uplink (transmit) SF
 LG02_TXSF: End Device Downlink (receive) SF

The TXSF is now set to default value:
 US915/AS923 : 923300000 , SF12BW500
 EU868: 869525000, SF12BW125

4.3.3 Test with OTAA LoRa end node (LoRa Shield + UNO)

Step 1: Create an OTAA device in TTN server --> Application page.

CONSOLE
COMMUNITY EDITION

Applications Gateways Supp

Applications > dragino_test_application1

APPLICATION EUIs [manage euis](#)

<> 70 B3 D5 7E F0 00 46 18

DEVICES [register device](#) [manage devices](#)

5 registered devices

dragino_test_application1 > Devices > otaa-device-1 > Settings

Device EUI
The serial number of your radio module, similar to a MAC address

A8 40 41 12 34 56 78 90 8 bytes

Application EUI

70 B3D57E F0 00 46 18

Activation Method

OTAA ABP

App Key
The key your device will use to set up sessions with the network

C3 95 15 93 AD 55 1A 83 2F 31 25 B6 7A F5 74 1D 16 bytes

Step 2: Input keys into Arduino Sketch.

The sketch for the LoRa Shield is in Arduino –IDE --> Examples -->LMIC_Arduino→ ttn-otaa

The screenshot shows the configuration interface for a LoRaWAN device. The activation method is set to OTAA. A yellow callout box states: "OTAA needs Device EUI, Application Key, APP Key. While put these keys in Arduino-LMIC library. Make sure the Device EUI and Application key are in lsb". Red arrows point from this callout to the Device EUI, Application EUI, and App Key input fields. The Device EUI is { 0x90, 0x78, 0x56, 0x34, 0x12, 0x41, 0x40, 0xA8 }, the Application EUI is { 0x18, 0x46, 0x00, 0xF0, 0x7E, 0xD5, 0xB3, 0x70 }, and the App Key is { 0xC3, 0x95, 0x15, 0x93, 0xAD, 0x55, 0x1A, 0x83, 0x2F, 0x31, 0x25, 0xB6, 0x7A, 0x1D }.

The screenshot shows the Arduino IDE with the ttn-otaa sketch. A yellow callout box says "Input Keys in Arduino Sketch". Red boxes highlight the key definitions in the code:

```
static const ul_t PROGMEM APPEUI[8] = { 0x18, 0x46, 0x00, 0xF0, 0x7E, 0xD5, 0xB3, 0x70 };
static const ul_t PROGMEM DEVEUI[8] = { 0x90, 0x78, 0x56, 0x34, 0x12, 0x41, 0x40, 0xA8 };
static const ul_t PROGMEM APPKEY[16] = { 0xC3, 0x95, 0x15, 0x93, 0xAD, 0x55, 0x1A, 0x83, 0x2F, 0x31, 0x25, 0xB6, 0x7A, 0xF5, 0x74, 0x1D };
```

Choose Arduino UNO to upload the sketch to LoRa Shield and UNO

The screenshot shows the Arduino IDE menu with the following options:

- Auto Format
- Archive Sketch
- Fix Encoding & Reload
- Serial Monitor (Ctrl+Shift+M)
- Serial Plotter (Ctrl+Shift+L)
- WiFi101 Firmware Updater
- Board: "Arduino/Genuino Uno" (highlighted with a red box)
- Port: "COM3" (highlighted with a red box)
- Get Board Info
- Programmer: "AVRISP mkII"
- Burn Bootloader

Step 3: Check Result for OTAA

```

COM9
End Device Log

Starting
RXMODE_RSSI
205: engineUpdate, opmode=0x8
Packet queued
253: EV_JOINING
1211: engineUpdate, opmode=0xc
360990: engineUpdate, opmode=0xc
361325: IXMODE, freq=868100000, len=23, SF=7, BW=125, CR=4/5, IH=0
674948: RXMODE_SINGLE, freq=868100000, SF=7, BW=125, CR=4/5, IH=0
681489: EV_JOINED
681516: engineUpdate, opmode=0x808
682020: IXMODE, freq=868100000, len=26, SF=7, BW=125, CR=4/5, IH=0
744428: RXMODE_SINGLE, freq=868100000, SF=7, BW=125, CR=4/5, IH=0
807697: RXMODE_SINGLE, freq=868100000, SF=9, BW=125, CR=4/5, IH=0
866799: EV_TXCOMPLETE (includes waiting for RX windows)
866849: engineUpdate, opmode=0x900
    
```

Send a Join Request and get EV_JOINED means OTAA join success.

dragino-1b6fb0 Status System Network Service Logout

Logread

Gateway Log shows TX / RX LoRa Packet

FreqINFO Report RxTxJson ErrorMessage

```

(TXPK) [down] {"bpk":{"imme":false,"lms":3667234979,"freq":868.1,"rfch":0,"pove":14,"modu":"LORA","datr":"SF7BW125","codr":4/5,"ipof":true,"size":33,"ncrc":
Receive(HEX)20f675628bf6ba47b13d97b2d53841c4a2c3d2b3f5784edac0ee41c09b52aed37
(RXPK) [up] {"rpk":{"time":"2018-10-19T15:49:50.666162Z","lms":3666685421,"chan":0,"rfch":1,"freq":868.100000,"stat":1,"modu":"LORA","datr":"SF7BW125",
Receive(HEX)201NFO
(RXPK) [{"time":"2018-10-19T15:49:51.310837Z","lms":3667330098,"chan":0,"rfch":1,"freq":868.100000,"stat":1,"modu":"LORA","datr":"SF7BW125",
Receive(HEX)00184600f07ed5b37090785634124140a83717b0b3a635
(RXPK) [{"time":"2018-10-19T15:51:12.288134Z","lms":3748307397,"chan":0,"rfch":1,"freq":868.100000,"stat":1,"modu":"LORA","datr":"SF7BW125",
(TXPK) [down] {"bpk":{"imme":false,"lms":3753307397,"freq":868.1,"rfch":0,"pove":14,"modu":"LORA","datr":"SF7BW125","codr":4/5,"ipof":true,"size":33,"ncrc":
Receive(HEX)202b875f11263b8feb06301731e6bb303649d809aeb7d2b01acd12a8a1555b35f
(RXPK) [up] {"rpk":{"time":"2018-10-19T15:51:16.768714Z","lms":3752787977,"chan":0,"rfch":1,"freq":868.100000,"stat":1,"modu":"LORA","datr":"SF7BW125",
Receive(HEX)202b875f11263b8feb06301731e6bb303649d809aeb7d2b01acd12a8a1555b35f
(RXPK) [{"time":"2018-10-19T15:51:17.419193Z","lms":3753438456,"chan":0,"rfch":1,"freq":868.100000,"stat":1,"modu":"LORA","datr":"SF7BW125",
Receive(HEX)40b32f0126800000169595d797e72e6ad20f6927984a9d0ae4a
(RXPK) [up] {"rpk":{"time":"2018-10-19T15:51:17.529606Z","lms":3753548866,"chan":0,"rfch":1,"freq":868.100000,"stat":1,"modu":"LORA","datr":"SF7BW125",
Receive(HEX)40b32f0126800100014c2175b7f5071dfead622d5abdbacc81c1
(RXPK) [up] {"rpk":{"time":"2018-10-19T15:52:20.726452Z","lms":3816745715,"chan":0,"rfch":1,"freq":868.100000,"stat":1,"modu":"LORA","datr":"SF7BW125",
Receive(HEX)40b32f0126800200013092d245bf71eabc672b4a9f96799a19c1
(RXPK) [up] {"rpk":{"time":"2018-10-19T15:53:24.029902Z","lms":3880049163,"chan":0,"rfch":1,"freq":868.100000,"stat":1,"modu":"LORA","datr":"SF7BW125",
Receive(HEX)40b32f0126800300018a0022e96ae280c87ed84b916191df32db
(RXPK) [up] {"rpk":{"time":"2018-10-19T15:54:27.346130Z","lms":3943365389,"chan":0,"rfch":1,"freq":868.100000,"stat":1,"modu":"LORA","datr":"SF7BW125",
    
```

https://console.thethingsnetwork.org/gateways/eui-a84

TTN Traffic Page shows the device status

Gateways > eui-a840411b6fb04150 > Traffic

Time	Freq	Mod	CR	SF	BW	SNR	Dev Addr	Payload Size
23:56:34	868.1	lora	4/5	SF 7	BW 125	61.7		26 bytes
23:55:30	868.1	lora	4/5	SF 7	BW 125	61.7		26 bytes
23:54:27	868.1	lora	4/5	SF 7	BW 125	61.7		26 bytes
23:53:24	868.1	lora	4/5	SF 7	BW 125	61.7		26 bytes
23:52:20	868.1	lora	4/5	SF 7	BW 125	61.7	1 dev addr: 26 01 2F B3	payload size: 26 bytes
23:51:17	868.1	lora	4/5	SF 7	BW 125	61.7	0 dev addr: 26 01 2F B3	payload size: 26 bytes
23:51:16	868.1	4/5	SF 7	BW 125	71.9			
23:51:12	868.1	4/5	SF 7	BW 125	61.7		app eui: 70 B3 D5 7E F0 00 46 18 dev eui: A8 40 41 12 34 56 78	

TTN Send a Join reply. LoRa End node must get this packet to finish Join. The frequency shows use 868.1Mhz frequency, must be the same as the "LG02_DNWFREQ" in Lmic config.c file

TTN Get Join request

Immediately send a Uplink message after join success

Note: The LG02_DNWFREQ value in Arduino_LMIC/src/lmic/config.h should match downlink frequency from TTN. TTN shows 868.1 here, So LG02_DNWFREQ should be 868100000

Step 4: Test Downlink

Applications > dragino_test_application1 > Devices > edwintest1

DOWNLINK

Schedule a Downlink message.
In TTN --> Application --> Device --> Data

Scheduling: replace first last

FPort: 1

Confirmed

Payload: bytes fields 67 54 12 38 99 5 bytes

Send

Gateways > eui-a840411b6fc44150 > Traffic ^{beta}

uplink downlink join 0 bytes X pause clear

time	frequency	mod.	CR	data rate	airtime (ms)	cnt	
23:35:40	868.1	lor	4/5	SF 7 BW 125	61.7	819	dev addr: 26 01 1C 22 payload size: 26 bytes
23:34:39	868.1	lor	4/5	SF 7 BW 125	51.5	2	dev addr: 26 01 1C 22 payload size: 18 bytes
23:34:39	868.1	lor	4/5	SF 7 BW 125	61.7	818	dev addr: 26 01 1C 22 payload size: 26 bytes

Downlink message Send out from TTN after the next uplink message arrive.
In TTN --> Gateway --> Traffic

```

Receive(HEX):40221c0126802f03015560e4a9861fadf0a66f8f086c2cc5bd3c
(RXPK):[up]{ "rxpk":{"time":"2018-10-07T15:31:29.364137Z","tmst":8525017
Receive(HEX):40221c0126803003012cc5d43fee0674456b05da5b5e7e59572
(RXPK):[up]{ "rxpk":{"time":"2018-10-07T15:32:32.725188Z","tmst":9158627
Receive(HEX):40221c012680310301c630b7dd7eede7120a368c84411d68255b
(RXPK):[up]{ "rxpk":{"time":"2018-10-07T15:33:36.001099Z","tmst":979138697,"chan":0,"rfch":1,"freq":868.100000,"stat":1,"modu":"LORA","datr":"SF7BW125","c
Receive(HEX):40221c012680320301266ea6ebbcf6832a5fe707fca27310a7c2
(RXPK):[up]{ "rxpk":{"time":"2018-10-07T15:34:39.279878Z","tmst":1042417475,"chan":0,"rfch":1,"freq":868.100000,"stat":1,"modu":"LORA","datr":"SF7BW125","c
(TXPK):[down]{ "txpk":{"imme":false,"tmst":1043417475,"freq":868.1,"rfch":0,"pwr":14,"modu":"LORA","datr":"SF7BW125","codr":"4/5","ipol":true,"size":18,"ncrc":
Receive(HEX):60221c012680020001ebce1d605dc3c3c649
(RXPK):[up]{ "rxpk":{"time":"2018-10-07T15:34:39.994318Z","tmst":1043131915,"chan":0,"rfch":1,"freq":868.100000,"stat":1,"modu":"LORA","datr":"SF7BW125"

```

Downlink message arrives gateway
In LG02 --> Service --> Logread

COM9

```

3217428074: engineUpdate, opmode=0x908
3217428598: IXMODE, freq=868100000, len=
Packet queued
3217494141: RXMODE_SINGLE, freq=868100000, SF=7, BW=125, CR=4/5, IH=0
3217557346: RXMODE_SINGLE, freq=868525000, SF=9, BW=125, CR=4/5, IH=0
-1077350851: EV_IXCOMPLETE (includes waiting for RX windows)
3217616511: engineUpdate, opmode=0x900
3221366512: engineUpdate, opmode=0x908
3221367037: IXMODE, freq=868100000, len=26, SF=7, BW=125, CR=4/5, IH=0
Packet queued
3221432515: RXMODE_SINGLE, freq=868100000, SF=7, BW=125, CR=4/5, IH=0
3221436475: Received downlink, window=RX1, port=1, ack=0
-1073530759: EV_IXCOMPLETE (includes waiting for RX windows)
Received
5
bytes of payload
3221436949: engineUpdate, opmode=0x800
3225186948: engineUpdate, opmode=0x808

```

Downlink message arrives LoRa Shield
In Arduino IDE --> Serial Monitor

4.3.4 Test with ABP LoRa end node (LoRa Shield + UNO)

Step 1: Create an ABP device in TTN server --> Application page. And change it to ABP mode.

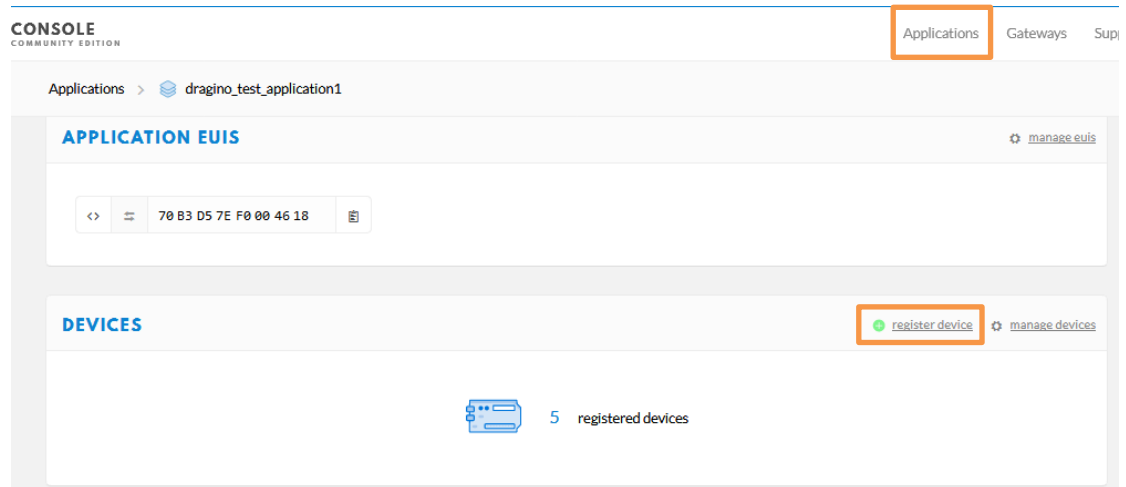

The screenshot shows the TTN Console interface. At the top, the 'CONSOLE COMMUNITY EDITION' logo is on the left, and navigation tabs for 'Applications', 'Gateways', and 'Supp' are on the right. The 'Applications' tab is selected and highlighted with an orange box. Below the navigation, the breadcrumb path is 'Applications > dragino_test_application1'. The main content area is divided into two sections: 'APPLICATION EUIs' and 'DEVICES'. The 'APPLICATION EUIs' section shows a single EUI: '70 B3 D5 7E F0 00 46 18'. The 'DEVICES' section shows '5 registered devices' and a 'register device' button, which is highlighted with an orange box. A 'manage euis' link is also visible in the top right of the APPLICATION EUIs section.

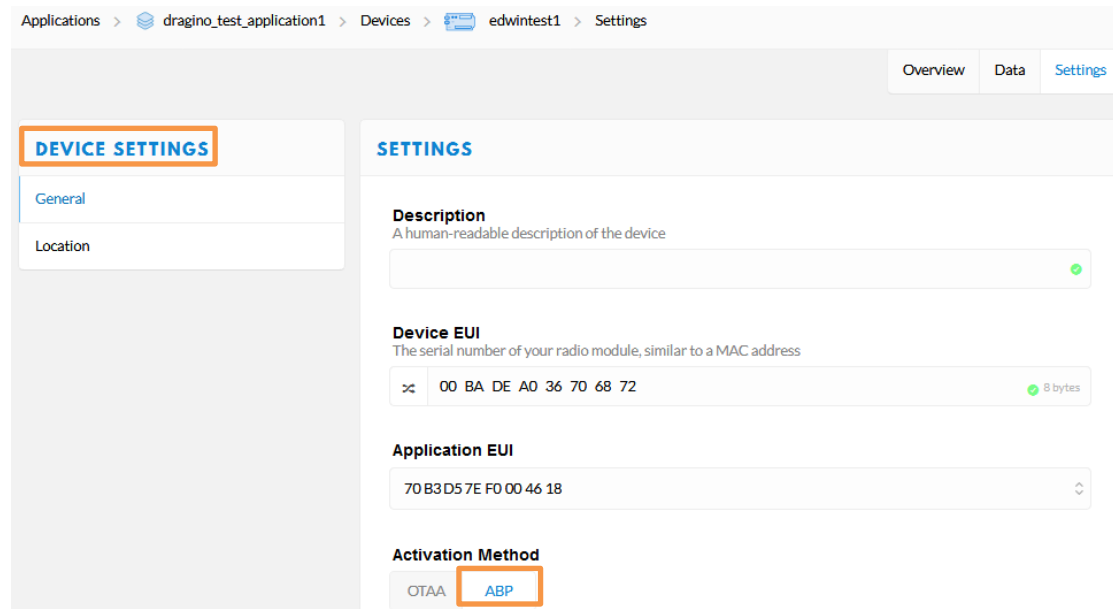

The screenshot shows the 'Settings' page for a device named 'edwintest1'. The breadcrumb path is 'Applications > dragino_test_application1 > Devices > edwintest1 > Settings'. At the top right, there are tabs for 'Overview', 'Data', and 'Settings', with 'Settings' being the active tab. On the left side, there is a 'DEVICE SETTINGS' sidebar with two options: 'General' and 'Location'. The 'General' option is selected. The main content area is titled 'SETTINGS' and contains several configuration fields:

- Description:** A text input field with a green checkmark icon on the right.
- Device EUI:** A text input field containing '00 BA DE A0 36 70 68 72' and a green checkmark icon with '8 bytes' next to it.
- Application EUI:** A dropdown menu showing '70 B3 D5 7E F0 00 46 18'.
- Activation Method:** Two radio buttons, 'OTAA' and 'ABP'. The 'ABP' button is selected and highlighted with an orange box.

Step 2: Input keys into Arduino Sketch.

The sketch for the LoRa Shield is in Arduino –IDE --> Examples -->LMIC_Arduino→ ttn-abp

Applications > dragino_test_application1 > Devices > edwintest1

TTN LoRaWAN End Device page

Application ID **dragino_test_application1**

Device ID edwintest1

Activation Method **ABP**

Device EUI <> 00 BA DE A0 36 70 68 72

Application EUI <> 70 B3 D5 7E F0 00 46 18

Device Address <> 26 01 1C 22

Network Session Key <> msb { 0x9A, 0xEA, 0xD0, 0x93, 0x06, 0xE3, 0x2B, 0x73, 0xDD, 0x54, 0x7B, 0x8B, 0xFF, 0xDC, 0x20, 0xF9 };

App Session Key <> msb { 0xB6, 0x07, 0x5B, 0xB5, 0xE4, 0xCE, 0x40, 0xA2, 0xA3, 0xEE, 0x7B, 0xDF, 0xDC, 0x23, 0x0E, 0x2B };

Make sure the Network Session Key and App Session Key are in MSB order

ttn-abp

Arduino Sketch ttn-abp

```
#include <lmic.h>
#include <hal/hal.h>
#include <SPI.h>

// LoRaWAN NwkSKey, network session key
// This is the default Semtech key, which is used by the early prototype TTN
// network
static const PROGMEM u1_t NwksKey[16] = { 0x9A, 0xEA, 0xD0, 0x93, 0x06, 0xE3, 0x2B, 0x73, 0xDD, 0x54, 0x7B, 0x8B, 0xFF, 0xDC, 0x20, 0xF9 };

// LoRaWAN AppSKey, application session key
// This is the default Semtech key, which is used by the early prototype TTN
// network
static const u1_t PROGMEM AppSKey[16] = { 0xB6, 0x07, 0x5B, 0xB5, 0xE4, 0xCE, 0x40, 0xA2, 0xA3, 0xEE, 0x7B, 0xDF, 0xDC, 0x23, 0x0E, 0x2B };

// LoRaWAN end-device address (DevAddr)
static const u4_t DevAddr = 0x26011C22 ; // <-- Change this address for every node!
```

Input the keys from TTN

Choose Arduino UNO to upload the sketch to LoRa Shield and UNO

Auto Format Ctrl+I

Archive Sketch

Fix Encoding & Reload

Serial Monitor Ctrl+Shift+M

Serial Plotter Ctrl+Shift+L

WiFi101 Firmware Updater

Board: "Arduino/Genuino Uno" >

Port: "COM3" >

Get Board Info

Programmer: "AVRISP mkII" >

Burn Bootloader

Step 3: Check Result for Uplink

COM9 Packet Sent From LoRa Shield.
In Arduino IDE --> Serial Monitor

```

3178173065: RXMODE_SINGLE, freq=889525000, SF=9, BW=125, CR=4/5, IH=0
-1116735050: EV_IXCOMPLETE (includes waiting for RX windows)
3178232311: engineUpdate, opmode=0x900
3181982310: engineUpdate, opmode=0x908
3181982835: TXMODE, freq=868100000, len=26, SF=7, BW=125, CR=4/5, IH=0
Packet queued
3182048313: RXMODE_SINGLE, freq=868100000, SF=7, BW=125, CR=4/5, IH=0
3182111581: RXMODE_SINGLE, freq=889525000, SF=9, BW=125, CR=4/5, IH=0
-1112796615: EV_IXCOMPLETE (includes waiting for RX windows)
    
```

/cgi-bin/luci/admin/gateway/lgwlog/3

dragino-1b6fc4 Status System Network Service Logout

Logread

FreqINFO Report RxTxJson ErrorMSG Packet Arrive Gateway.
In page Service-->logread

```

Receive(HEX):40221c012680190301808a82034b8fc78df3dc7904968c850405
(RXPk): [up] [{"rxpk":{"time":"2018-10-07T15:08:16.815203Z","tmst":3754920098,"chan":0,"rfch":1,"freq":868.100000,"stat":1,"modu":"LORA","datr":"SF7BW125"},
Receive(HEX):40221c0126801a0301b8eec0b06dd48c6f810faa2110301a3ba0
(RXPk): [up] [{"rxpk":{"time":"2018-10-07T15:09:20.146556Z","tmst":3818251446,"chan":0,"rfch":1,"freq":868.100000,"stat":1,"modu":"LORA","datr":"SF7BW125"},
Receive(HEX):40221c0126801b0301dc1f9e3ed124cb56b7351a517378118e7d
(RXPk): [up] [{"rxpk":{"time":"2018-10-07T15:10:23.388949Z","tmst":3881493842,"chan":0,"rfch":1,"freq":868.100000,"stat":1,"modu":"LORA","datr":"SF7BW125"},
Receive(HEX):40221c0126801c030106621e6fb4169d499d7b50b8f8c9a7f0fe
(RXPk): [up] [{"rxpk":{"time":"2018-10-07T15:11:26.714474Z","tmst":3944819367,"chan":0,"rfch":1,"freq":868.100000,"stat":1,"modu":"LORA","datr":"SF7BW125"},
Receive(HEX):40221c0126801d0301ca9fce94baebe3b4a9bcd09f95037b7b69
(RXPk): [up] [{"rxpk":{"time":"2018-10-07T15:12:30.024255Z","tmst":4008129142,"chan":0,"rfch":1,"freq":868.100000,"stat":1,"modu":"LORA","datr":"SF7BW125"},
Receive(HEX):40221c0126801e0301f727938d7254dd03180a4bc6b1763243e3
(RXPk): [up] [{"rxpk":{"time":"2018-10-07T15:13:33.339652Z","tmst":4071444547,"chan":0,"rfch":1,"freq":868.100000,"stat":1,"modu":"LORA","datr":"SF7BW125"},
    
```

Gateways > eui-a840411b6fc44150 > Traffic ^{beta} Overview Traffic Settings

GATEWAY TRAFFIC ^{beta} Packet Arrive TTN.
In TTN --> Gateway --> Traffic

uplink downlink join 0 bytes pause clear

time	frequency	mod.	CR	data rate	airtime(ms)	cnt	
23:24:06	868.1	lora	4/5	SF 7 BW 125	61.7	808	dev addr: 26 01 1C 22 payload size: 26 bytes
23:23:03	868.1	lora	4/5	SF 7 BW 125	61.7	807	dev addr: 26 01 1C 22 payload size: 26 bytes
23:21:59	868.1	lora	4/5	SF 7 BW 125	61.7	806	dev addr: 26 01 1C 22 payload size: 26 bytes
23:20:56	868.1	lora	4/5	SF 7 BW 125	61.7	805	dev addr: 26 01 1C 22 payload size: 26 bytes

Applications > dragino_test_application1 > Devices > edwintest1 > Data Overview Data Se

APPLICATION DATA Packet Arrive TTN Device Page.
In TTN --> Application --> Device --> Data pause

Filters uplink downlink activation ack error

time	counter	port	
23:30:26	814	1	payload: 48 65 6C 6C 6F 2C 20 77 6F 72 6C 64 21
23:29:22	813	1	payload: 48 65 6C 6C 6F 2C 20 77 6F 72 6C 64 21

Step 4: Test Downlink

Applications > dragino_test_application1 > Devices > edwintest1

DOWNLINK

Schedule a Downlink message.
In TTN --> Application --> Device --> Data

Scheduling: replace first last

FPort: 1

Confirmed

Payload: bytes fields 67 54 12 38 99 5 bytes

Send

Gateways > eui-a840411b6fc44150 > Traffic ^{beta}

uplink downlink join 0 bytes X pause clear

time	frequency	mod.	CR	data rate	airtime (ms)	cnt	
23:35:40	868.1	lora	4/5	SF 7 BW 125	61.7	819	dev addr: 26 01 1C 22 payload size: 26 bytes
23:34:39	868.1	lora	4/5	SF 7 BW 125	51.5	2	dev addr: 26 01 1C 22 payload size: 18 bytes
23:34:39	868.1	lora	4/5	SF 7 BW 125	61.7	818	dev addr: 26 01 1C 22 payload size: 26 bytes

Downlink message Send out from TTN after the next uplink message arrive.
In TTN --> Gateway --> Traffic

```

Receive(HEX):40221c0126802f03015560e4a9861fadf0a66f8f086c2cc5bd3c
(RXPK):[up]{ "rxpk":{"time":"2018-10-07T15:31:29.364137Z","tmst":"8525017
Receive(HEX):40221c0126803003012cc5d43fee0674456b05da5b5e7e59572
(RXPK):[up]{ "rxpk":{"time":"2018-10-07T15:32:32.725188Z","tmst":"9158627
Receive(HEX):40221c012680310301c630b7dd7eede7120a368c84411d68255b
(RXPK):[up]{ "rxpk":{"time":"2018-10-07T15:33:36.001099Z","tmst":"979138697,"chan":0,"rfch":1,"freq":868.100000,"stat":1,"modu":"LORA","datr":"SF7BW125","c
Receive(HEX):40221c012680320301266ea6ebbcf6832a5fe707fca27310a7c2
(RXPK):[up]{ "rxpk":{"time":"2018-10-07T15:34:39.279878Z","tmst":"1042417475,"chan":0,"rfch":1,"freq":868.100000,"stat":1,"modu":"LORA","datr":"SF7BW125","c
(TXPK):[down]{ "txpk":{"imme":false,"tmst":"1043417475,"freq":868.1,"rfch":0,"pwr":14,"modu":"LORA","datr":"SF7BW125","codr":"4/5","ipol":true,"size":18,"ncrc":
Receive(HEX):60221c012680020001ebce1d605dc3c3c649
(RXPK):[up]{ "rxpk":{"time":"2018-10-07T15:34:39.994318Z","tmst":"1043131915,"chan":0,"rfch":1,"freq":868.100000,"stat":1,"modu":"LORA","datr":"SF7BW125"

```

Downlink message arrives gateway
In LG02 --> Service --> Logread

COM9

```

3217428074: engineUpdate, opmode=0x908
3217428598: IXMODE, freq=868100000, len=
Packet queued
3217494141: RXMODE_SINGLE, freq=868100000, SF=7, BW=125, CR=4/5, IH=0
3217557346: RXMODE_SINGLE, freq=868525000, SF=9, BW=125, CR=4/5, IH=0
-1077350851: EV_IXCOMPLETE (includes waiting for RX windows)
3217616511: engineUpdate, opmode=0x900
3221366512: engineUpdate, opmode=0x908
3221367037: IXMODE, freq=868100000, len=26, SF=7, BW=125, CR=4/5, IH=0
Packet queued
3221432515: RXMODE_SINGLE, freq=868100000, SF=7, BW=125, CR=4/5, IH=0
3221436475: Received downlink, window=RX1, port=1, ack=0
-1073530759: EV_IXCOMPLETE (includes waiting for RX windows)
Received
5
bytes of payload
3221436949: engineUpdate, opmode=0x800
3225186948: engineUpdate, opmode=0x808

```

Downlink message arrives LoRa Shield
In Arduino IDE --> Serial Monitor

5. Example 2: Control LoRa radio directly as general LoRa transceiver

There are two ways to use the LoRa Radio of Gateway: a) Through `pkt_fwd` process , b) Use the Radio SPI device separately.

5.1 User LoRa Radio via `pkt_fwd`

5.1.1 Use `pkt_fwd` to receive

When user chooses the MQTT/TCP-IP/Customized mode, the `lg02_pkt_fwd` will auto start. It will listen the LoRa Radio Channel 1 base on the setting in the web setting.

Channel 1 Radio Settings

Radio settings for Channel 1

RX Frequency (Unit:Hz)	<input type="text" value="868100000"/>
RX Spreading Factor	<input type="text" value="SF7"/>
TX Frequency (Unit:Hz)	<input type="text" value="868100000"/>
TX Spreading Factor	<input type="text" value="SF9"/>
Coding Rate	<input type="text" value="4/5"/>
Signal Bandwidth	<input type="text" value="125 kHz"/>
Preamble Length	<input type="text" value="8"/> <small>Length range: 6 ~ 65536</small>
Encryption Key	<input type="text" value="Encryption Key"/>

If the LoRa end node send data in the match format, the `pkt_fwd` will store the data for further use, the logic of this receive part please see [Customized Script](#).

5.1.2 Use `pkt_fwd` to transmit

(This is a new feature since 2019-Jan-30)

The `pkt_fwd` also open a thread to listen to local files under directory `/var/iot/push/`. Once there is a file in this directory, the thread will check if it is an outgoing file and send out the LoRa message if format match. Below is the file example (json format):

```
{"txpk":{"imme":false,"tmst":861608339,"freq":925.1,"rfch":0,"powe":20,"modu":"LORA","datr":"SF7BW500","codr":"4/5","ipol":true,"size":22,"ncrc":true,"data":"YEklB CaqCgADQAIAcQM6AP8B9TYzUA=="}}
```

Explain:

Name	Type	Function
<code>imme</code>	bool	Send packet immediately (will ignore <code>tmst</code> & time)
<code>tmst</code>	number	Send packet on a certain timestamp value (will ignore time)
<code>tmms</code>	number	Send packet at a certain GPS time (GPS synchronization required)

-----|-----|-----

`imme` | bool | Send packet immediately (will ignore `tmst` & time)

`tmst` | number | Send packet on a certain timestamp value (will ignore time)

`tmms` | number | Send packet at a certain GPS time (GPS synchronization required)

freq | number | TX central frequency in MHz (unsigned float, Hz precision)
 rfch | number | Concentrator "RF chain" used for TX (unsigned integer)
 powe | number | TX output power in dBm (unsigned integer, dBm precision)
 modu | string | Modulation identifier "LORA" or "FSK"
 datr | string | LoRa datarate identifier (eg. SF12BW500)
 datr | number | FSK datarate (unsigned, in bits per second)
 codr | string | LoRa ECC coding rate identifier
 fdev | number | FSK frequency deviation (unsigned integer, in Hz)
 ipol | bool | Lora modulation polarization inversion
 prea | number | RF preamble size (unsigned integer)
 size | number | RF packet payload size in bytes (unsigned integer)
 data | string | Base64 encoded RF packet payload, padding optional
 nrcr | bool | If true, disable the CRC of the physical layer (optional)

Not all field are necessary, below is an example:

- 1) First set up a LoRa Shield with this code: [LoRaReceiver](#). So the LoRa Shield will receive the data at frequency 915.6Mhz, SF7BW125, CR: 4/5
- 2) Edit a file (any name) under `/var/iot/push/` with below content.

```
{ "txpk": { "freq": 915.6, "powe": 20, "datr": "SF7BW125", "codr": "4/5", "ipol": false, "data": "test" } }
```

And then we can see below output

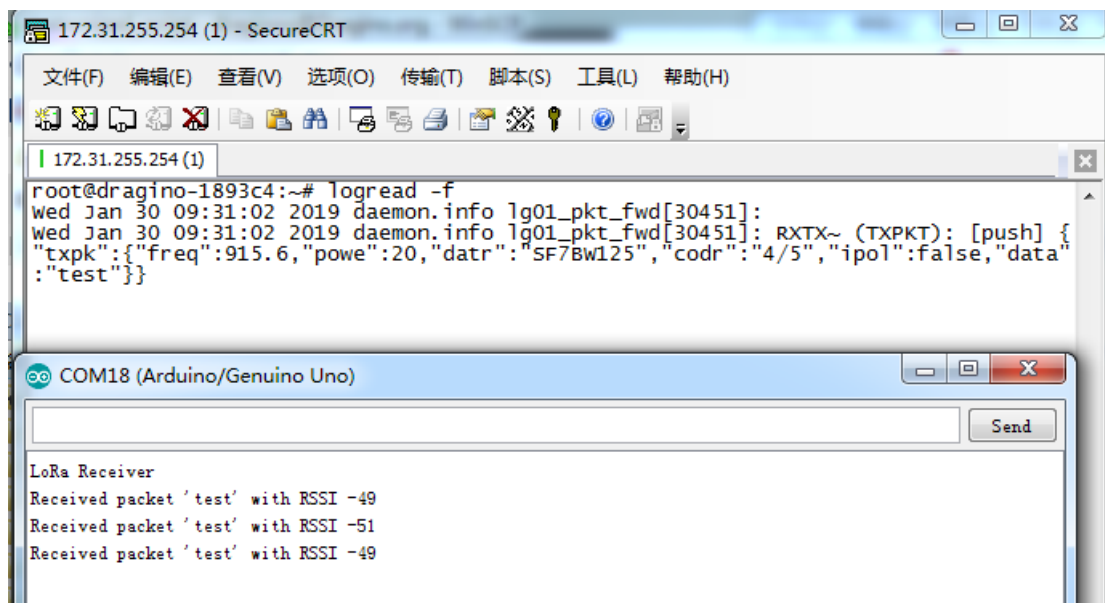

5.2 Use LoRa radio device directly

There are two SPI devices in LG02, user can use `lg02_single_rx_tx` to control this SPI device for transmit and receive. When use the `lg02_single_rx_tx` command to transmit, it will initiate the SPI device on each call and it will add delay to start transmit, this will be slower than the `pkt_fwd` mode

Step 1: Disable packet forward

With firmware higher than version LG02_LG08--build-v5.1.1545908833-20181227-1908, select "Disabled" in IoT Service page.

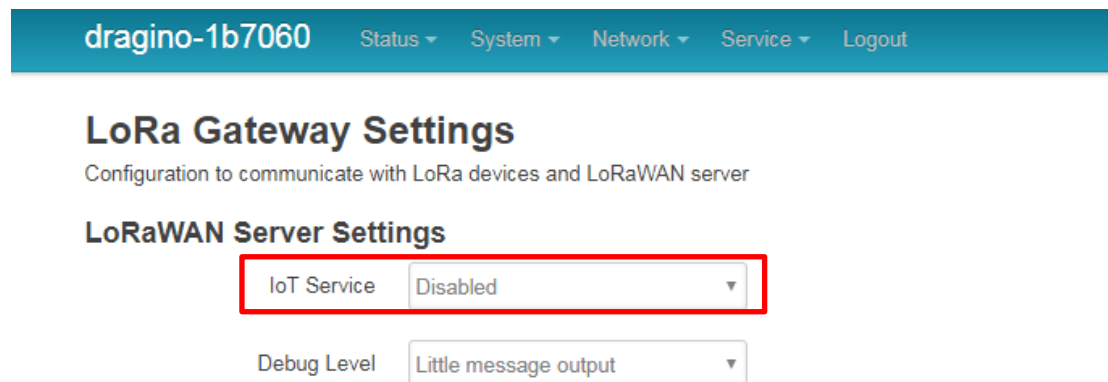

The screenshot shows the web interface for a Dragino gateway. At the top, there is a navigation bar with the gateway ID 'dragino-1b7060' and menu items for Status, System, Network, Service, and Logout. Below this is the 'LoRa Gateway Settings' section, which includes a sub-section for 'LoRaWAN Server Settings'. In this sub-section, the 'IoT Service' dropdown menu is highlighted with a red border and is currently set to 'Disabled'. Below it, the 'Debug Level' dropdown menu is set to 'Little message output'.

Step 2: Use `lg02_single_rx_tx` to receive

Usage: `lg02_single_rx_tx` [-d radio_dev] select radio 1 or 2 (default:1)

[-t] set as tx

[-r] set as rx

[-f frequency] (default:868500000)

[-s spreadingFactor] (default: 7)

[-b bandwidth] default: 125k

[-w syncword] default: 52(0x34)reserver for lorawan

[-p message] message to send

[-o filepath] payload output to file

[-v] show version

[-h] show this help and exit Use Radio 1 to transmit:

Command:

```
root@dragino-1b6fb0:~# lg02_single_rx_tx -r -d 1 -f 915600000
```

Use radio 1 to receive at frequency 9156000000

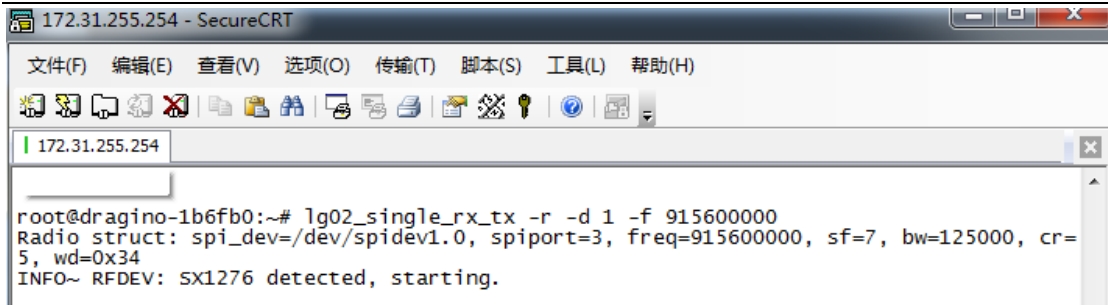

Then set up a LoRa node to send out LoRa packet, We use [LoRa Shield](#) + UNO in this example. The library use in Arduino UNO is [LoRa-Master](#). And the source code is [LoRaSender](#).

Result screen shot:

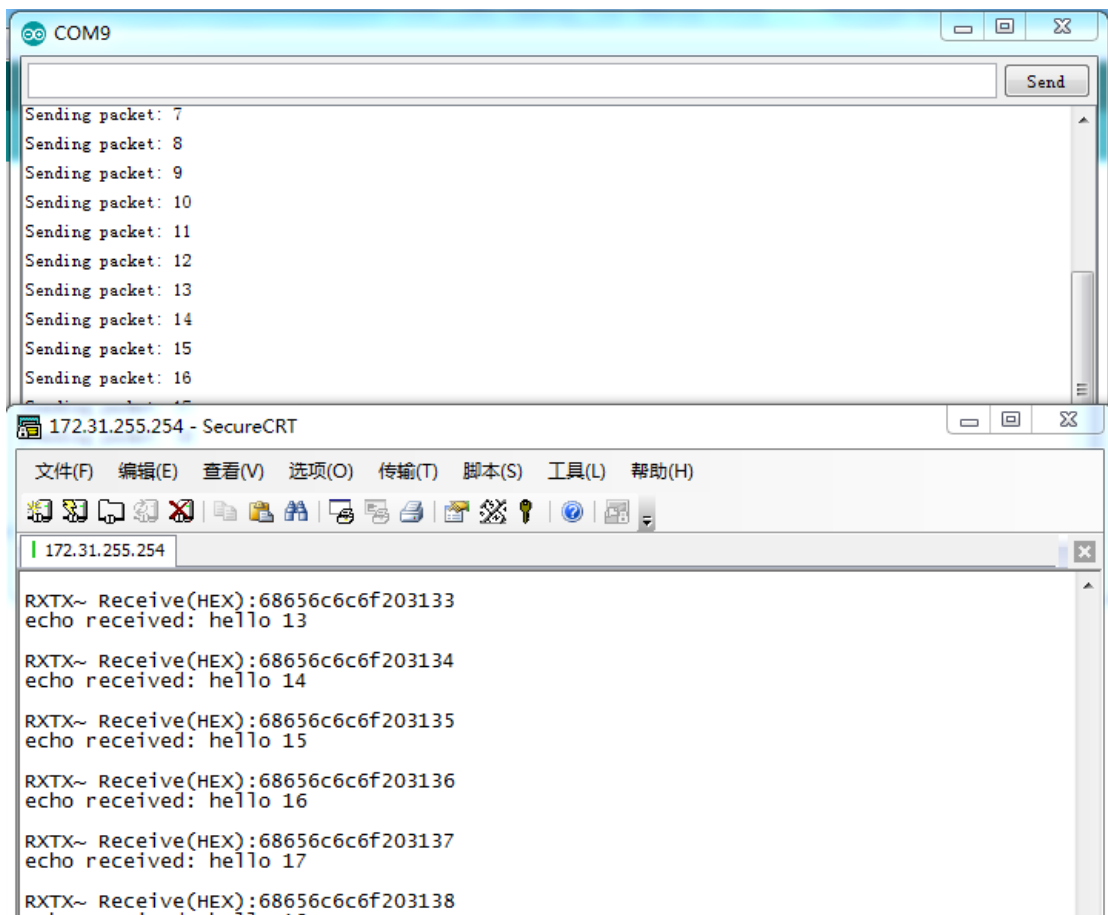

Step 3: Use lg02_single_rx_tx to transmit

Command:

```
root@dragino-1b6fb0:~# lg02_single_rx_tx -t -d 2 -f 915600000 -m "hello from dragino"
```

Use radio 2 to transmit a message at frequency 915600000

Set up a LoRa node to send out LoRa packet, We use [LoRa Shield](#) + UNO in this example. The library use in Arduino UNO is [LoRa-Master](#). And the source code is [LoRaReceiver](#).

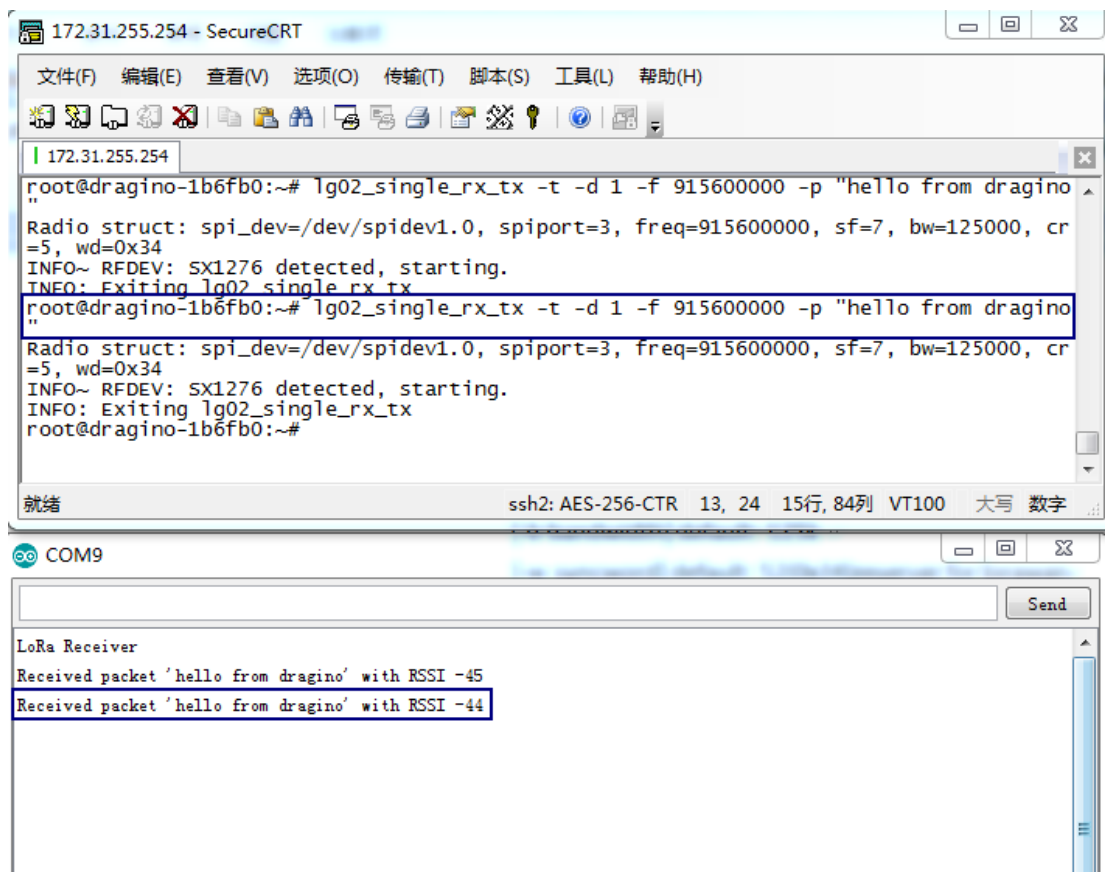

6. Example 3: MQTT Transfer Mode

MQTT is a machine-to-machine (M2M)/"Internet of Things" connectivity protocol. It was designed as an extremely lightweight publish/subscribe messaging transport. It is useful for connections with remote locations where a small code footprint is required and/or network bandwidth is at a premium. For example, it has been used in sensors communicating to a broker via satellite link, over occasional dial-up connections with healthcare providers, and in a range of home automation and small device scenarios.

Most IoT server support MQTT connection, for those servers, we can use MQTT to connect it to publish data or subscribe to a channel.

Topology for ThingSpeak Connection:

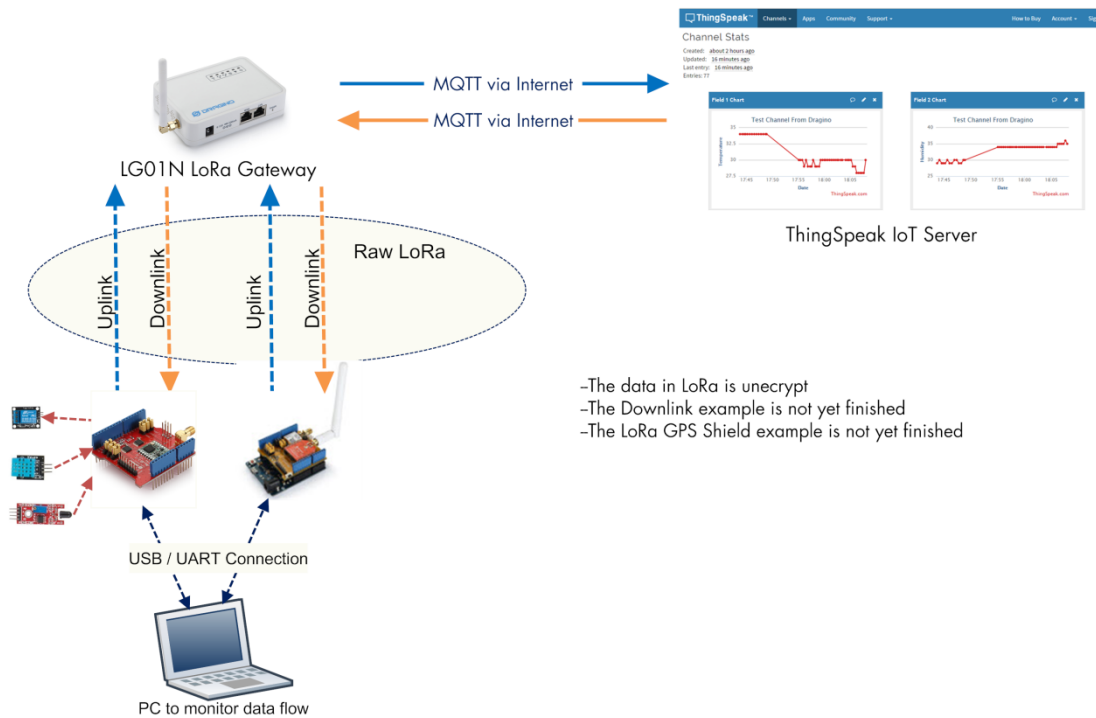

Most IoT server support MQTT connection, for those servers, we can use MQTT to connect it to publish data or subscribe to a channel.

A detail of how to use MQTT plus Video instruction can be found at:

http://wiki.dragino.com/index.php?title=MQTT_Forward_Instruction

7. Example 4: TCP IP Client Mode

In the TCP IP Client mode, LG02 can accept LoRa packets and send it to the TCP-IP server. The working topology is as below. In this mode, The Uplink LoRa packets should use a customized format.

TCP/IP Client mode:

Use LG02 / OLG02 as a LoRa Gateway to forward packet to IoT Server in TCP/IP Client Mode

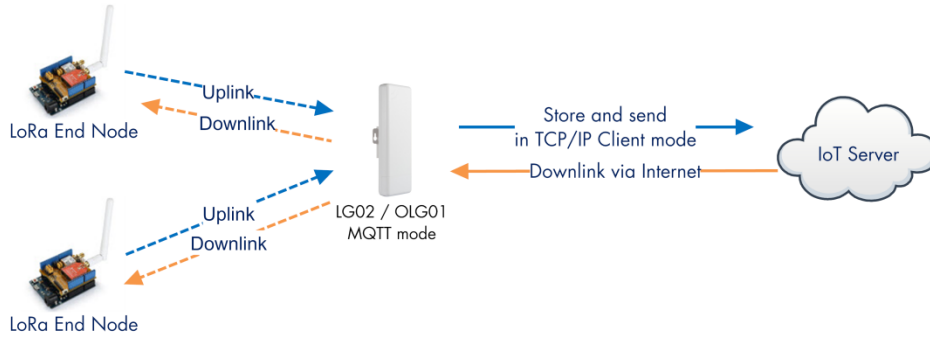

Operate Principle:

- > The LoRa end node sends data to LG02 gateway via private LoRa protocol. LG02 stores the sensor data.
- > LG02 sends the sensor data to IoT Server via general TCP/IP Client mode.

Step1: Select TCP-IP Client mode

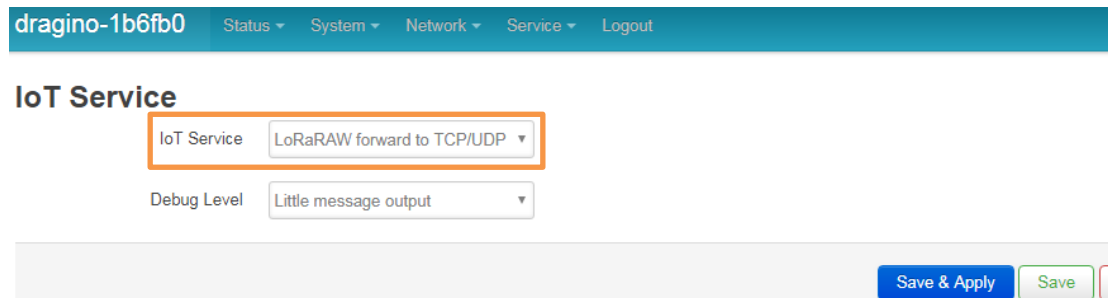

Step2: Configure the Radio1 channel with the match radio settings frequency as the LoRa End Node

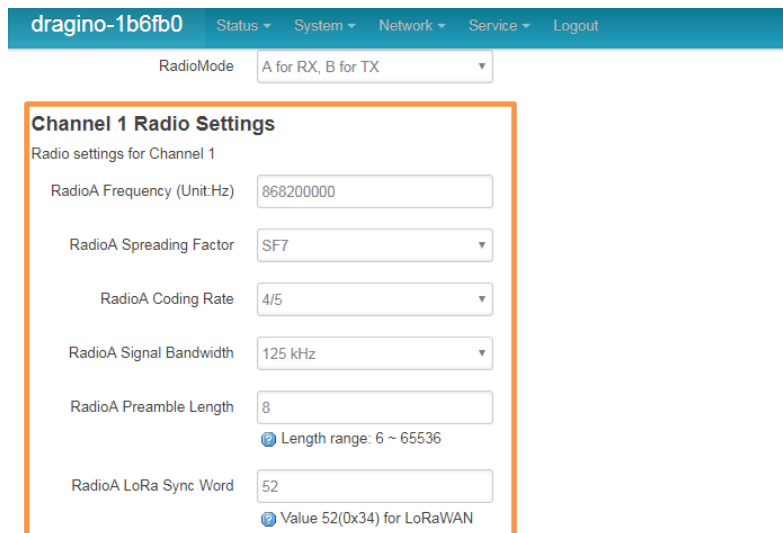

Step3: Configure TCP Server Info

Note: Gateway may receive many LoRa packets, it will only transfer the packet with the same ID as specify in the channel.

Step4: About uplink data format

The LoRa end node should upload the data with below format:

Uplink Format: **<Channel_ID>data**

For example, if we have configured 2 channels 12345 and 34567.

And there is are three LoRa End nodes sending: 12345,34567,78

The LG02 will accept the data from 12345 and 34567, it will ignore the data from Node 78

Case 1:

Node 12345 send <12345>field1=0.0&field2=1102.0

Node 34567 doesn't send anything

The TCP/IP server will get {"12345":"field1=0.0&field2=1102.0"}

Case 2:

Node 12345 send <12345>field1=0.0&field2=1102.0

Node 34567 send <34567>temp=34

The TCP/IP server will get {"34567":"temp=34","12345":"field1=0.0&field2=1102.0"}

LoRa End Device reference source code: [check this link](#).

8. Example 5: Write a customized script

LG02 supports customized script to process LoRa data. This chapter describes about the data format from LoRa End node and How to write the script.

The data flow from LoRa End Node to LG02 is as below:

How customized script works:

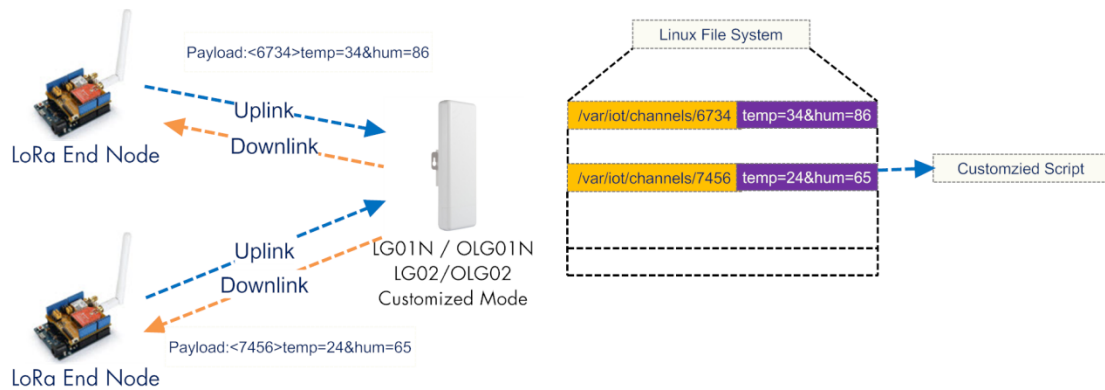

Operate Principle:

- > LoRa End Node sends the data to gateway in specify format: <node_ID>value
- > Gateway get the data and will put the data in corresponding files under /var/iot/channels.
- > The customized script interact with these channels files. So developer can focus on writing this script.

Example: Store Data in a file.

Step 1: Choose LoRa customized script mode

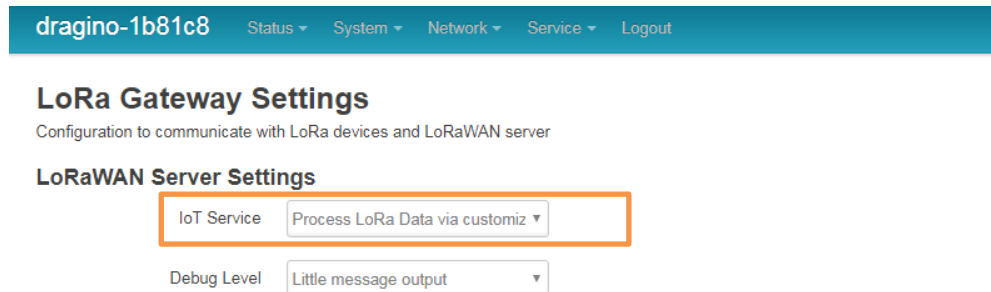

Step 2: Configure LoRa Frequency

Channel 1 Radio Settings

Radio settings for Channel 1

RadioA Frequency (Unit:Hz)

RadioA Spreading Factor

RadioA Coding Rate

Step 3: Choose the customized script

Customized Script

Run a Customized Script to process LoRa Data, parameters are optional and defined in script

General Settings

Script Name	<input type="text" value="store_data_to_file.sh"/>
Parameter 1	<input type="text" value="/var/sensor_data"/>

The directory to store customized script is in `/etc/lora/customized_scripts/`. User can write a new script and put it under this directory for their application. The web will auto detect it.

Step 4: Configure the LoRa End Device to send sensor data.

Here is an example code for LoRa Shield: [End Device Code](#)

Outputs:

End node send out packages:

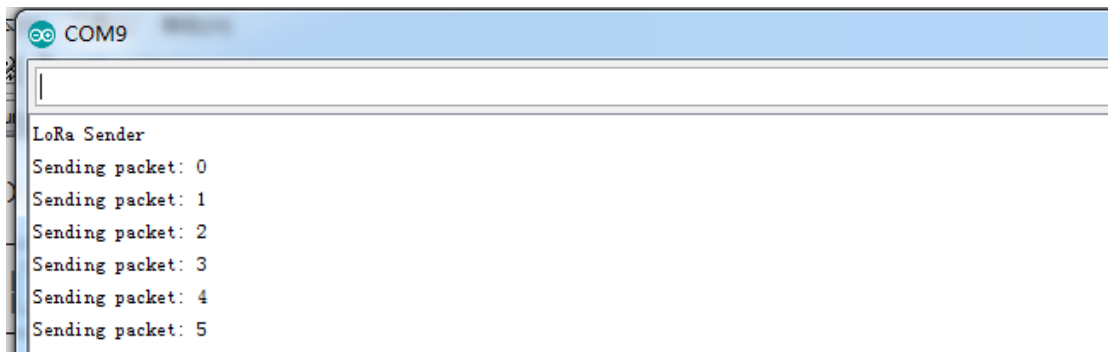

```
COM9
LoRa Sender
Sending packet: 0
Sending packet: 1
Sending packet: 2
Sending packet: 3
Sending packet: 4
Sending packet: 5
```

Gateway receive packet & Script find packet

```
root@dragino-1b81c8:~# logread -f
Sun Jan 1 00:47:08 2012 user.notice root: [IoT]: Found field1=25&field2=87 at Local Channel: 10009
Sun Jan 1 00:47:08 2012 user.notice root: [IoT]: Append at /var/sensor_data
Sun Jan 1 00:47:13 2012 daemon.info lg02_pkt_fwd[31105]:
Sun Jan 1 00:47:13 2012 daemon.info lg02_pkt_fwd[31105]: RXTX~ Receive(HEX):3c31303030393e6669656c64313d3239266669656c64323d3933
Sun Jan 1 00:47:14 2012 user.notice root: [IoT]: Found field1=29&field2=93 at Local Channel: 10009
Sun Jan 1 00:47:14 2012 user.notice root: [IoT]: Append at /var/sensor_data
Sun Jan 1 00:47:23 2012 daemon.info lg02_pkt_fwd[31105]:
Sun Jan 1 00:47:23 2012 daemon.info lg02_pkt_fwd[31105]: RXTX~ Receive(HEX):3c31303030393e6669656c64313d3238266669656c64323d3934
Sun Jan 1 00:47:26 2012 user.notice root: [IoT]: Found field1=28&field2=94 at Local Channel: 10009
Sun Jan 1 00:47:26 2012 user.notice root: [IoT]: Append at /var/sensor_data
```

Script store data into file

```
root@dragino-1b81c8:~# cat /var/sensor_data
Sun Jan 1 00:15:26 UTC 2012 :<1234> 123443
Sun Jan 1 00:46:26 UTC 2012 :<10009> field1=32&field2=94
Sun Jan 1 00:46:44 UTC 2012 :<10009> field1=32&field2=94
Sun Jan 1 00:46:56 UTC 2012 :<10009> field1=28&field2=93
Sun Jan 1 00:47:08 UTC 2012 :<10009> field1=25&field2=87
Sun Jan 1 00:47:14 UTC 2012 :<10009> field1=29&field2=93
Sun Jan 1 00:47:26 UTC 2012 :<10009> field1=28&field2=94
Sun Jan 1 00:47:38 UTC 2012 :<10009> field1=25&field2=90
Sun Jan 1 00:47:44 UTC 2012 :<10009> field1=27&field2=87
Sun Jan 1 00:47:56 UTC 2012 :<10009> field1=32&field2=88
Sun Jan 1 00:48:08 UTC 2012 :<10009> field1=32&field2=94
Sun Jan 1 00:48:20 UTC 2012 :<10009> field1=25&field2=87
Sun Jan 1 00:48:26 UTC 2012 :<10009> field1=28&field2=94
Sun Jan 1 00:48:38 UTC 2012 :<10009> field1=34&field2=92
Sun Jan 1 00:48:50 UTC 2012 :<10009> field1=25&field2=88
Sun Jan 1 00:48:56 UTC 2012 :<10009> field1=34&field2=93
Sun Jan 1 00:49:08 UTC 2012 :<10009> field1=31&field2=90
Sun Jan 1 00:49:20 UTC 2012 :<10009> field1=32&field2=91
Sun Jan 1 00:49:26 UTC 2012 :<10009> field1=27&field2=92
Sun Jan 1 00:49:38 UTC 2012 :<10009> field1=25&field2=88
```

9. Example 6: LoRaWAN Packet Relay mode

The LG02 has two radio channels, we can use these two channels as LoRaWAN relay to improve the network coverage.

9.1 How it works

Basic concept: Get data in Radio 1 with match frequency, transmit the same data on Radio2 with pre-configure frequency.

This mode works for below LoRa protocol:

- ✓ LoRaWAN ABP mode and only be able to relay one frequency.
- ✓ Radiohead Library.
- ✓ Simple LoRa protocol.

Configuration is as below:

Step 1: Choose LoRaWAN/Raw relay mode

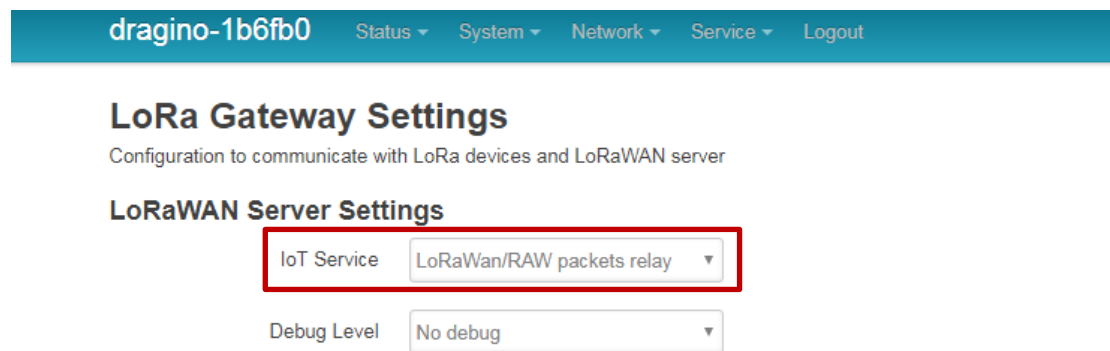

dragino-1b6fb0 Status System Network Service Logout

LoRa Gateway Settings

Configuration to communicate with LoRa devices and LoRaWAN server

LoRaWAN Server Settings

IoT Service: LoRaWan/RAW packets relay

Debug Level: No debug

Step 2: Configure receive channel info

For example, if we want to receive all packets on:

Frequency:915.2Mhz, sf=7, bw=125000, cr=5, wd=0x34,bandwidth= 125k. below is the configure.

Channel 1 Radio Settings

Radio settings for Channel 1

RadioA Frequency (Unit:Hz)	<input type="text" value="915200000"/>
RadioA Spreading Factor	<input type="text" value="SF7"/>
RadioA Coding Rate	<input type="text" value="4/5"/>
RadioA Signal Bandwidth	<input type="text" value="125 kHz"/>
RadioA Preamble Length	<input type="text" value="8"/> <input checked="" type="checkbox"/> Length range: 6 ~ 65536
RadioA LoRa Sync Word	<input type="text" value="52"/> <input checked="" type="checkbox"/> Value 52(0x34) for LoRaWAN
Encryption Key	<input type="text" value="Encryption Key"/>

Step 3: Configure transmit channel info

For example, if we want to transmit all received packets on:

Frequency: 903.9Mhz, sf=7, bw=125000, cr=5, wd=0x34, bandwidth= 125k. Below is the configuration.

Channel 2 Radio Settings

Radio settings for Channel 2

RadioB Frequency (Unit:Hz)	<input type="text" value="903900000"/>
RadioB Spreading Factor	<input type="text" value="SF7"/>
RadioB Coding Rate	<input type="text" value="4/5"/>
RadioB Signal Bandwidth	<input type="text" value="125 kHz"/>
RadioB Preamble Length	<input type="text" value="8"/> <input checked="" type="checkbox"/> Length range: 6 ~ 65536
RadioB LoRa Sync Word	<input type="text" value="52"/> <input checked="" type="checkbox"/> Value 52(0x34) for LoRaWAN
Encryption Key	<input type="text" value="Encryption Key"/>

Now the LG02 will transfer all packets receive on Radio 1 (915.2Mhz, sf=7, bw=125000, cr=5, wd=0x34,bandwidth= 125k) to Radio 2 (903.9Mhz, sf=7, bw=125000, cr=5, wd=0x34, bandwidth= 125k)

Below is the debug info for reference:

```
root@dragino-1b6fb0:~# logread -f
Mon Dec 17 13:18:27 2018 daemon.info lg02_pkt_fwd[6370]:
Mon Dec 17 13:18:27 2018 daemon.info lg02_pkt_fwd[6370]: RXTX~ Receive(HEX):408b1c0126001524027944e22ef8b78848a1005b60
Mon Dec 17 13:18:27 2018 daemon.info lg02_pkt_fwd[6370]:
Mon Dec 17 13:18:27 2018 daemon.info lg02_pkt_fwd[6370]: INFO~Transmit at SF7BW125 on 903.900000.
Mon Dec 17 13:19:27 2018 daemon.info lg02_pkt_fwd[6370]:
Mon Dec 17 13:19:27 2018 daemon.info lg02_pkt_fwd[6370]: RXTX~ Receive(HEX):408b1c012600162402f115475169ebb39c23b278d4
Mon Dec 17 13:19:27 2018 daemon.info lg02_pkt_fwd[6370]:
Mon Dec 17 13:19:27 2018 daemon.info lg02_pkt_fwd[6370]: INFO~Transmit at SF7BW125 on 903.900000.
Mon Dec 17 13:20:27 2018 daemon.info lg02_pkt_fwd[6370]:
Mon Dec 17 13:20:27 2018 daemon.info lg02_pkt_fwd[6370]: RXTX~ Receive(HEX):408b1c012600172402b10a8a261da8a7c70220c76f
Mon Dec 17 13:20:27 2018 daemon.info lg02_pkt_fwd[6370]:
Mon Dec 17 13:20:27 2018 daemon.info lg02_pkt_fwd[6370]: INFO~Transmit at SF7BW125 on 903.900000.
Mon Dec 17 13:20:30 2018 daemon.info lg02_pkt_fwd[6370]:
Mon Dec 17 13:20:30 2018 daemon.info lg02_pkt_fwd[6370]: RXTX~ Receive(HEX):f08c5484c0b4e9575b3e0926ee0da8a8082b0b6a31e51079d9813010688a
Mon Dec 17 13:20:30 2018 daemon.info lg02_pkt_fwd[6370]:
Mon Dec 17 13:20:30 2018 daemon.info lg02_pkt_fwd[6370]: INFO~Transmit at SF7BW125 on 903.900000.
Mon Dec 17 13:20:32 2018 daemon.info lg02_pkt_fwd[6370]: INFO~ Exiting Lora service program
```

9.2 Limitation

While use this mode to enlarge the LoRaWAN coverage, there is limitation because the LG02 only listen one Frequency and DR, while the LoRaWAN end node transmit the data on multiply frequency and different DR. For example, in EU868 LoRaWAN, the end node LoRaWAN settings are:

EU863-870

Uplink:

868.1 - SF7BW125 to SF12BW125

868.3 - SF7BW125 to SF12BW125 and SF7BW250

868.5 - SF7BW125 to SF12BW125

867.1 - SF7BW125 to SF12BW125

867.3 - SF7BW125 to SF12BW125

867.5 - SF7BW125 to SF12BW125

867.7 - SF7BW125 to SF12BW125

867.9 - SF7BW125 to SF12BW125

868.8 – FSK

Downlink:

Uplink channels 1-9 (RX1)

869.525 - SF9BW125 (RX2 downlink only)

For uplink: if we set LG02 to listen on 868.3 , SF7, BW125, and transmit at 868.3,SF7,BW125. The LG02 will receive all end node's packet at 868.3 SF7BW125 and can't receive other frequency from end node. Which means the LG02 can only extend the uplink for 868.3 SF7BW125.

For downlink: Due to IQ inverter issue, the end node can't get relay packet from LG02. So OTAA mode can't work. User need to use ABP mode.

10. More features

10.1 Remote Access

Remote Access Devices for management:

See

http://wiki.dragino.com/index.php?title=Main_Page#Remote_Access_Gateway_via_Reverse_SSH

10.2 More instructions

http://wiki.dragino.com/index.php?title=Main_Page#LoRa.2FLoRaWAN_Gateway_Instruction

11. Linux System

The LG02 bases on OpenWrt Linux System. It is open source, and user are free to configure and modify the inside Linux settings.

11.1 SSH Access for Linux console

User can access to the Linux console via SSH protocol. Make sure your PC and the LG01 is in the same network, then use a SSH tool (such as [putty](#)) to access it. Below are screenshots:

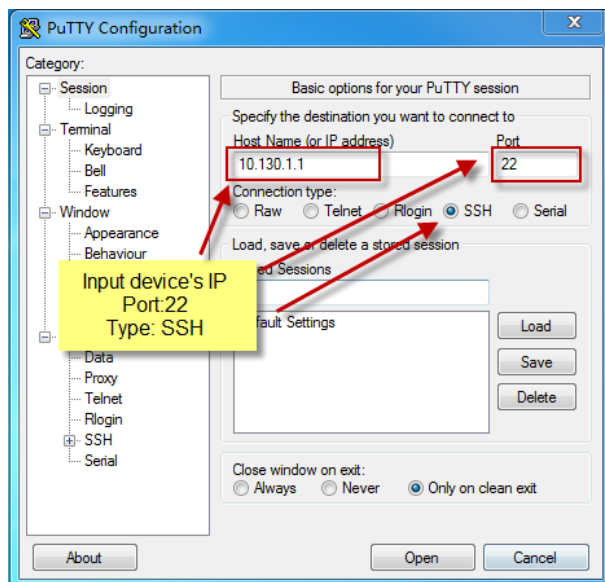

IP address: IP address of LG02

Port: 22 or 2222

User Name: **root**

Password: **dragino** (default)

After log in, you will be in the Linux console and type command here.

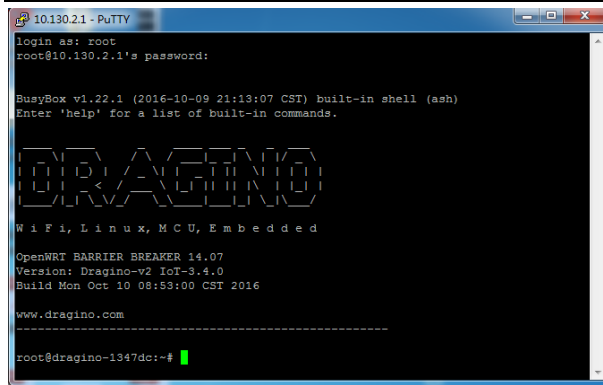

```
1013021 - PuTTY
login as: root
root@10.130.2.1's password:

BusyBox v1.22.1 (2016-10-09 21:13:07 CST) built-in shell (ash)
Enter 'help' for a list of built-in commands.

DRAGINO
W i F i , L i n u x , M C U , E m b e d d e d

OpenWRT BARRIER BREAKER 14.07
Version: Dragino-V2 IoT-3.4.0
Build Mon Oct 10 08:53:00 CST 2016

www.dragino.com
-----
root@dragino-1347dc:~#
```

11.2 Edit and Transfer files

The LG02 support **SCP protocol** and has a built **SFTP server**. There are many ways to edit and transfer files using these two protocols. One of the easiest is through [WinSCP](#) utility. After access via WinSCP to the device, use can use a FTP alike window to drag / drop files to the LG02 or Edit the files directly in the windows. Screenshot is as below:

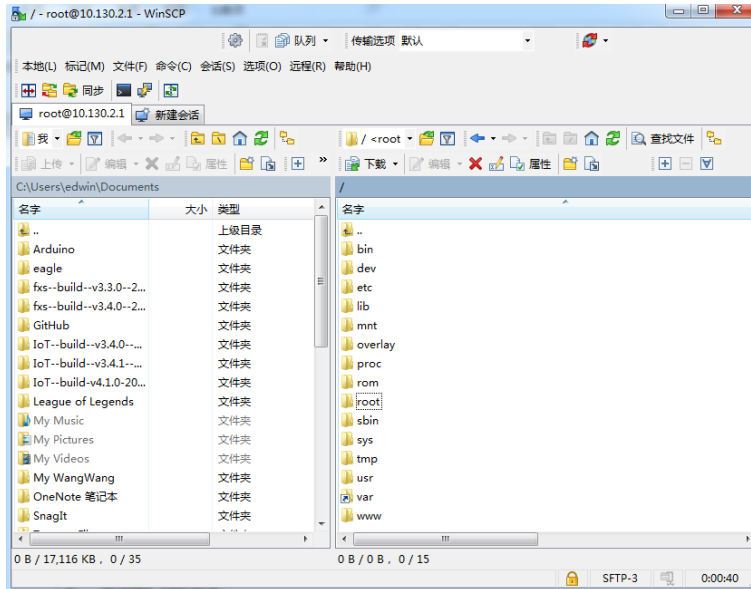

11.3 File System

The LG02 has a 16MB flash and a 64MB RAM. The /var and /tmp directory are in the RAM, contents stored in /tmp and /var will be erased after reboot the device. Other directories are in the flash and will keep after reboot.

Use cat /proc/mtd to see all blocks/partitions.

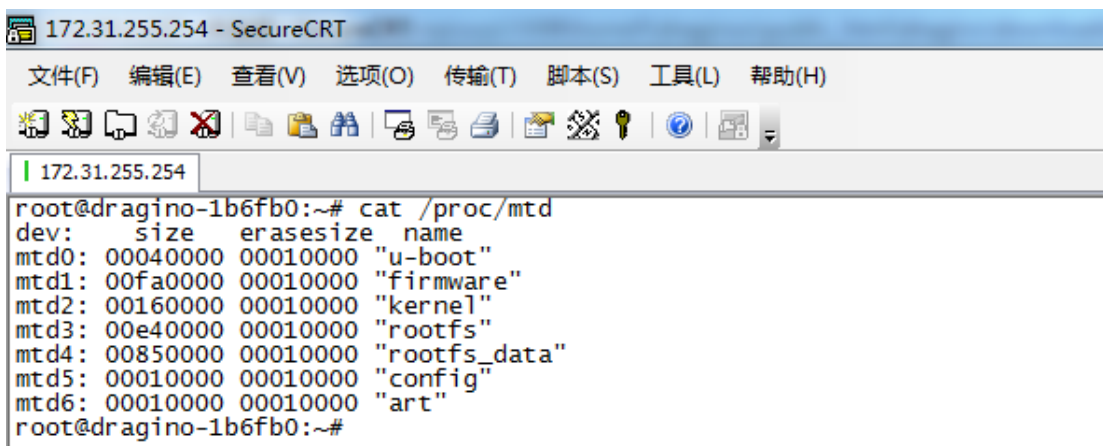

```

172.31.255.254 - SecureCRT
文件(F) 编辑(E) 查看(V) 选项(O) 传输(T) 脚本(S) 工具(L) 帮助(H)
| 172.31.255.254
root@dragino-1b6fb0:~# cat /proc/mtd
dev:   size  erasesize  name
mtd0: 00040000 00010000 "u-boot"
mtd1: 00fa0000 00010000 "firmware"
mtd2: 00160000 00010000 "kernel"
mtd3: 00e40000 00010000 "rootfs"
mtd4: 00850000 00010000 "rootfs_data"
mtd5: 00010000 00010000 "config"
mtd6: 00010000 00010000 "art"
root@dragino-1b6fb0:~#
    
```

- ✓ "u-boot" // for boot-loader
- ✓ "firmware" // combination of kernel & rootfs
- ✓ "kernel" // Linux kernel
- ✓ "rootfs" // Linux rootfs

- ✓ "rootfs_data" //inside rootfs, all data store here.
- ✓ "config" // a separate partition doesn't include file system
- ✓ "art" // radio data and board ID.

Use df command to see available flash & RAM:

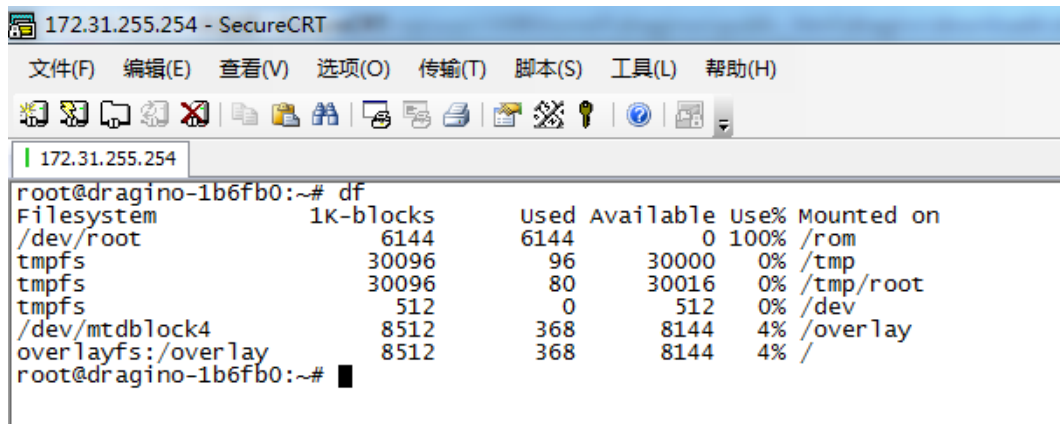

```

172.31.255.254 - SecureCRT
文件(F) 编辑(E) 查看(V) 选项(O) 传输(T) 脚本(S) 工具(L) 帮助(H)
172.31.255.254
root@dragino-1b6fb0:~# df
Filesystem          1k-blocks      Used Available  Use% Mounted on
/dev/root            6144          6144         0 100% /rom
tmpfs                30096           96    30000     0% /tmp
tmpfs                30096           80    30016     0% /tmp/root
tmpfs                 512             0         512     0% /dev
/dev/mtdblock4      8512           368     8144     4% /overlay
overlayfs:/overlay 8512           368     8144     4% /
root@dragino-1b6fb0:~#

```

tmpfs 30096 96 30000 0% /tmp // RAM: reset after reboot,
 /dev/mtdblock4 8512 368 8144 4% /overlay //Flash: Remain after reboot

Reset to factory default:

mtdd erase rootfs_data -r

Except /tmp and /var. all data will be store in flash. /tmp and /var are store in RAM

11.4 Package maintain system

LG02 uses [OPKG package maintain system](#). There are more than 3000+ packages available in our package server for user to install for their applications. For example, if user wants to add iperf tool, they can install the related packages and configure LG02 to use iperf

Below is some examples opkgs command, more please refer [OPKG package maintain system](#)

In Linux Console run:

```
root@dragino-169d30:~# opkg update // to get the latest packages list
```

```
root@dragino-169d30:~# opkg list //shows the available packages
```

```
root@dragino-169d30:~# opkg install iperf // install iperf, it will auto install the required packages.
```

```
root@dragino-169d30:/etc/opkg# opkg install iperf
```

```
Installing iperf (2.0.12-1) to root...
```

```
Downloading http://downloads.openwrt.org/snapshots/packages/mips_24kc/base/iperf_2.0.12-1_mips_24kc.ipk
```

```
Installing uclibcxx (0.2.4-3) to root...
```

```
Downloading
```

```
http://downloads.openwrt.org/snapshots/packages/mips_24kc/base/uclibcxx_0.2.4-3_mips_24kc.ipk
```

```
Configuring uclibcxx.
```

```
Configuring iperf.
```

12. Upgrade Linux Firmware

We keep improving the LG02 Linux side firmware for new features, bug fixes. The latest firmware can be found on [LG02 Firmware & release note](#)

The file named as **dragino-LG02_LG08----xxxxx-squashfs-sysupgrade.bin** is the upgrade Image. There are different methods to upgrade, as below:

12.1 Upgrade via Web UI

Go to the page: **Web --> System --> Back Up and flash firmware**, Select the image and click Flash Image, the image will be uploaded to the device and then click Process Update to upgrade.

System will auto boot to the new firmware after upgrade.

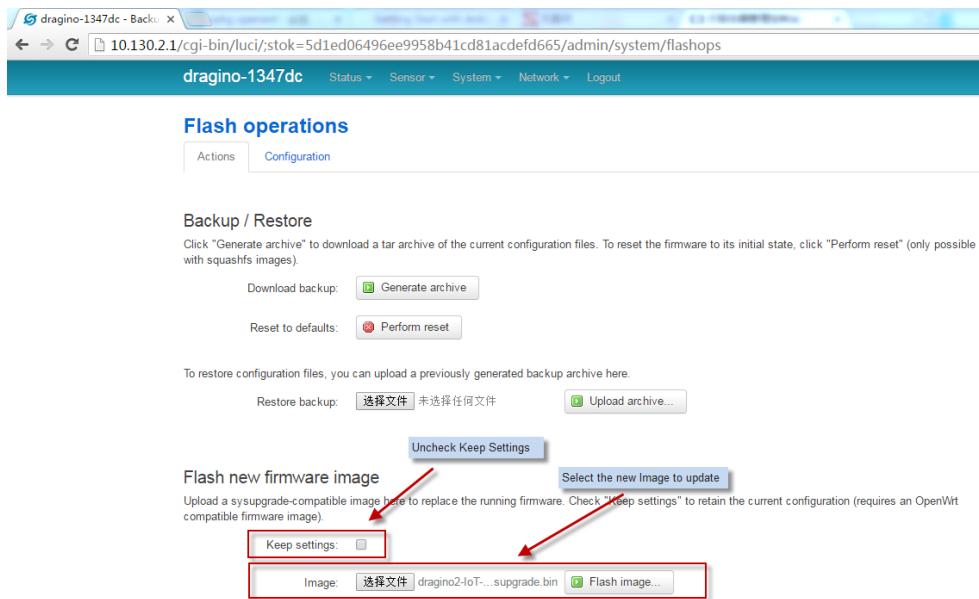

12.2 Upgrade via Linux console

SCP the firmware to the system **/var** directory and then run

```
root@OpenWrt:~# /sbin/sysupgrade -n /var/Your_Image
```

note: it is important to transfer the image in the **/var** directory, otherwise it may exceed the flash size.

13. FAQ

13.1 Why there is 433/868/915 version LoRa part?

Different country has different rules for the ISM band for using the LoRa. Although the LoRa chip can support a wide range of Frequency, we provide different version for best tune in the LoRa part. That is why we provide different version of LoRa.

13.2 What is the frequency range of LG02 LoRa part?

The chip used in the LoRa part is:

Version	LoRa IC	Support Frequency	Best Tune Frequency
433	Semtech SX1278	Band2(LF): 410 ~525Mhz Band3(LF): 137 ~175Mhz	433Mhz
868	Semtech SX1276	Band1(HF): 862 ~1020Mhz	868Mhz
915	Semtech SX1276	Band1(HF): 862 ~1020Mhz	915Mhz

User can set the LoRa within above frequency range in the software.

13.3 What does “Limited support on LoRaWAN”?

The base requirement to fully compatible with LoRaWAN protocol requires the gateway support 8 channels. The LG02 only support two channels and can only support limited LoRaWAN protocol. Below are limitations:

1/ It works only on one frequency at a time. It can support multiply end nodes, but all end nodes must transmit data at the same frequency so the LG02 can receive it. For example: if the End node transmits at 868.1Mhz, The LG02’s RX setting must be 868.1Mhz so to receive this packet.

2/ It works only for one DR at a time. DR specifies the Spreading Factor and Bandwidth. In LG02, even the rx frequency match , if DR doesn’t match, it still can’t get the sensor data.

3/ LoRaWAN compatible issue

In LoRaWAN protocol, the LoRaWAN end nodes send data in a hopping frequency. Since LG02 only supports one single frequency, it will only be able to receive the packets sent from the same radio parameters (frequency & DR) in LG02.

For example, in EU868, a standard LoRaWAN device may send the data in eight frequencies with different Frequency & SF, such as:

```
LMIC_setupChannel(0, 868100000, DR_RANGE_MAP(DR_SF12, DR_SF7), BAND_CENTI); // g-band
LMIC_setupChannel(1, 868300000, DR_RANGE_MAP(DR_SF12, DR_SF7B), BAND_CENTI); // g-band
LMIC_setupChannel(2, 868500000, DR_RANGE_MAP(DR_SF12, DR_SF7), BAND_CENTI); // g-band
LMIC_setupChannel(3, 867100000, DR_RANGE_MAP(DR_SF12, DR_SF7), BAND_CENTI); // g-band
LMIC_setupChannel(4, 867300000, DR_RANGE_MAP(DR_SF12, DR_SF7), BAND_CENTI); // g-band
LMIC_setupChannel(5, 867500000, DR_RANGE_MAP(DR_SF12, DR_SF7), BAND_CENTI); // g-band
```

```
LMIC_setupChannel(6, 867700000, DR_RANGE_MAP(DR_SF12, DR_SF7), BAND_CENTI); // g-band
LMIC_setupChannel(7, 867900000, DR_RANGE_MAP(DR_SF12, DR_SF7), BAND_CENTI); // g-band
LMIC_setupChannel(8, 868800000, DR_RANGE_MAP(DR_FSK, DR_FSK), BAND_MILLI); // g2-band
```

So the LG02 will only be able to receive the 868100000, SF7 packet and will not receive others. Means only one packet will arrive the TTN server in every 8 packets sent from the LoRaWAN end node.

If user wants to receive all packets from LoRaWAN end node, user needs to set up the LoRaWAN node to send packets in a single frequency.

4/ Downlink & OTAA issue

According to the LoRaWAN class A spec, the end node will open two receive windows to get the message from LoRaWAN server for OTAA or downlink function. These two receive windows are quite short (milliseconds), if LoRa packet from the gateway can't reach End Node in the receive window time, the end node won't get the rx message and Downlink / OTAA won't work.

In our LoRaWAN example, the Arduino LMIC library is modified to enlarge the RX window to let OTAA & downlink work.

13.4 Can I develop my own application for LG02?

Yes, the fastest way to develop own software is through the SDK. The instruction is here:

https://github.com/dragino/openwrt_lede-18.06/blob/master/README.md#how-to-develop-a-c-software-before-build-the-image

13.5 Can I make my own firmware for LG02? Where can I find the source code of LG02?

Yes, User can make own firmware for LG02 for branding purpose or add customized application.

The LG02 source code and compile instruction can be found at:

https://github.com/dragino/openwrt_lede-18.06

13.6 Can I change the LoRa behavior of LG02?

Yes, Developer can change the LoRa control behavior of LG02. The source code of the LoRa

controller in LG02 is here: <https://github.com/dragino/dragino-packages/tree/lg02/lg02-pkt-fw>

And the compile method can refer: [Compile an application](#).

13.7 On OTAA mode, if I use the other frequency, how should I modify in the library?

In page [OTAA](#), We use frequency 904.6Mhz for sending. According to the LoRaWAN protocol, if the device Join the network successfully, the server will downlink the reply. The different intervals of frequency, the receiving frequency of the end node is also different.

Ex1: We use 914.2Mhz frequency.

We can input the command: `logread -f`

```

Wed Sep 12 01:39:19 2018 daemon.info lg02_pkt_fw[14341]: INFO (json): [down] {"txpk":{"imne":false,"tmst":2831770149,"freq":927.5,"rfch":0,"powe":20,"modu":"LoRA","data":{"sf7bw500","codr":"4/5","ipol":true,"size":17,"ncrc":true,"data":{"IiadG+uy4yL7RAFx5HX0A="}}}
Wed Sep 12 01:39:19 2018 daemon.info lg02_pkt_fw[14341]: SF=0x07
Wed Sep 12 01:39:19 2018 daemon.info lg02_pkt_fw[14341]: Transmit at SF7bw500 on 927.500000.
Wed Sep 12 01:39:20 2018 daemon.info lg02_pkt_fw[14341]: SF=0x07
Wed Sep 12 01:39:20 2018 daemon.info lg02_pkt_fw[14341]: Transmit at SF7bw500 on 927.500000.
Wed Sep 12 01:39:20 2018 daemon.info lg02_pkt_fw[14341]: Downlink done: count_us=2831770149
Wed Sep 12 01:39:21 2018 daemon.info lg02_pkt_fw[14341]: INFO (json): [down] {"txpk":{"imne":false,"tmst":2833763738,"freq":927.5,"rfch":0,"powe":20,"modu":"LoRA","data":{"sf7bw500","codr":"4/5","ipol":true,"size":17,"ncrc":true,"data":{"IG6NEMK9p5v1jF98P1xb2v1="}}}
Wed Sep 12 01:39:21 2018 daemon.info lg02_pkt_fw[14341]: SF=0x07
Wed Sep 12 01:39:21 2018 daemon.info lg02_pkt_fw[14341]: Transmit at SF7bw500 on 927.500000.
Wed Sep 12 01:39:22 2018 daemon.info lg02_pkt_fw[14341]: SF=0x07
Wed Sep 12 01:39:22 2018 daemon.info lg02_pkt_fw[14341]: Transmit at SF7bw500 on 927.500000.
Wed Sep 12 01:39:22 2018 daemon.info lg02_pkt_fw[14341]: Downlink done: count_us=2833763738
Wed Sep 12 01:39:22 2018 daemon.info lg02_pkt_fw[14341]: Receive(HEX):40ad2a012680000010a2fd88ae57fa9451d478e5a1e693d8b

```

We should modify this on `<lorabase.h>`, save and re-upload the sketch.

```

enum {
    US915_125kHz_UPFBASE = 914200000,
    US915_125kHz_UPFSTEP = 0,
    US915_500kHz_UPFBASE = 902320000,
    US915_500kHz_UPFSTEP = 0,
    US915_500kHz_DNFBASE = 927500000, //receive
    US915_500kHz_DNFSTEP = 0
};

```

For the result:

▲ 10:06:25	116	1	payload: 68 65 6C 6C 6F 20 77 6F 72 6C 64 21
▲ 10:06:11	115	1	payload: 68 65 6C 6C 6F 20 77 6F 72 6C 64 21
▲ 10:05:57	114	1	payload: 68 65 6C 6C 6F 20 77 6F 72 6C 64 21
▲ 10:05:43	113	1	payload: 68 65 6C 6C 6F 20 77 6F 72 6C 64 21
▲ 10:05:29	112	1	payload: 68 65 6C 6C 6F 20 77 6F 72 6C 64 21

Ex2: We use 903.0Mhz frequency

We can input the command: logread -f

```
root@dragino-19a944:~# logread -f
wed Sep 12 02:11:31 2018 daemon.info lg02_pkt_fwd[20677]:
wed Sep 12 02:11:31 2018 daemon.info lg02_pkt_fwd[20677]: INFO (json): [down] [{"txpk":{"imme":false,"tmst":468442152,"freq":923.3,"rfch":0,"pove":20,"modu":"LORA","dat
r":{"SF7Bw500","codr":"4/5","tpol":true,"size":17,"incrc":true,"data":"1g1ky0uey3XLdM7FSovbR8g="}}]
wed Sep 12 02:11:31 2018 daemon.info lg02_pkt_fwd[20677]: SF=0x07
wed Sep 12 02:11:31 2018 daemon.info lg02_pkt_fwd[20677]:
wed Sep 12 02:11:32 2018 daemon.info lg02_pkt_fwd[20677]: Transmit at SF7Bw500 on 923.300000.
wed Sep 12 02:11:32 2018 daemon.info lg02_pkt_fwd[20677]: SF=0x07
wed Sep 12 02:11:32 2018 daemon.info lg02_pkt_fwd[20677]:
wed Sep 12 02:11:32 2018 daemon.info lg02_pkt_fwd[20677]: Transmit at SF7Bw500 on 923.300000.
wed Sep 12 02:11:32 2018 daemon.info lg02_pkt_fwd[20677]: Downlink done: count_us=468442152
wed Sep 12 02:11:32 2018 daemon.info lg02_pkt_fwd[20677]:
wed Sep 12 02:11:32 2018 daemon.info lg02_pkt_fwd[20677]: Receive(HEX):00ac2301d07ed5b370907cb65d67c64a00cd3586bb5c88
wed Sep 12 02:11:36 2018 daemon.info lg02_pkt_fwd[20677]:
wed Sep 12 02:11:36 2018 daemon.info lg02_pkt_fwd[20677]: INFO (json): [up] [{"txpk":{"time":"2018-09-12T02:11:36.210520Z","tmst":472538265,"chan":0,"rfch":1,"freq":90
3.000000,"stat":1,"modu":"LORA","datr":{"SF7Bw125","codr":"4/5","tsnr":7.8,"rss1":-34,"size":23,"data":"AKWjAdB+1DNwKHy2XwFGsqDNVya7X1q="}}]
注: 注册Windows
```

▲ 10:13:33	1	1	payload: 68 65 6C 6C 6F 20 77 6F 72 6C 64 21
▼ 10:13:21	0		
▲ 10:13:20	0	1	retry payload: 68 65 6C 6C 6F 20 77 6F 72 6C 64 21
If join the network successfully, it will send a reply.			
+	10:13:15	dev addr: 26 01 20 71 app eui: 70 B3D5 7E D001 23AC dev eui: 00 4AC6 67 5D B67C 90	

We should modify this on <lorabase.h>, save and re-upload the sketch.

```
enum { US915_125kHz_UPFBASE = 903000000,
        US915_125kHz_UPFSTEP = 0,
        US915_500kHz_UPFBASE = 902320000,
        US915_500kHz_UPFSTEP = 0,
        US915_500kHz_DNFBASE = 923300000, //receive
        US915_500kHz_DNFSTEP = 0
};
```

For the result:

▲ 10:16:57	16	1	payload: 68 65 6C 6C 6F 20 77 6F 72 6C 64 21
▲ 10:16:43	15	1	payload: 68 65 6C 6C 6F 20 77 6F 72 6C 64 21
▲ 10:16:29	14	1	payload: 68 65 6C 6C 6F 20 77 6F 72 6C 64 21
▲ 10:16:15	13	1	payload: 68 65 6C 6C 6F 20 77 6F 72 6C 64 21
▲ 10:16:01	12	1	payload: 68 65 6C 6C 6F 20 77 6F 72 6C 64 21
▲ 10:15:47	11	1	payload: 68 65 6C 6C 6F 20 77 6F 72 6C 64 21

13.8 How can I reset the device to factory default?

User can reset the device to factory default in different ways:

Method 1:

Reset via Web UI. Click the button in Web UI --> System --> Back up / Flash firmware --> Perform Reset

Method 2:

Reset in Linux console, command is below:

```
root@dragino-1b8288:~# firstboot
```

This will erase all settings and remove any installed packages. Are you sure?

[N/y]

y

/dev/mtdblock4 is mounted as /overlay, only erasing files

```
root@dragino-1b8288:~# reboot
```

13.9 Can I control the LEDs?

Except the PWR LED and sensor LED, all other LEDs can be controlled by developer.

Control Globe LED:

ON: echo 1 > /sys/class/leds/dragino2:red:wlan/brightness

OFF: echo 0 > /sys/class/leds/dragino2:red:wlan/brightness

14. Trouble Shooting

14.1 I get kernel error when install new package, how to fix?

In some case, when install package, it will generate kernel error such as below:

```
root@dragino-16c538:~# opkg install kmod-dragino2-si3217x_3.10.49+0.2-1_ar71xx.ipk
```

```
Installing kmod-dragino2-si3217x (3.10.49+0.2-1) to root...
```

```
Collected errors:
```

```
* satisfy_dependencies_for: Cannot satisfy the following dependencies for
```

```
kmod-dragino2-si3217x:
```

```
* kernel (= 3.10.49-1-4917516478a753314254643facdf360a) *
```

```
* opkg_install_cmd: Cannot install package kmod-dragino2-si3217x.
```

In this case, user can use the `--force-depends` option to install such package.

```
opkg install kmod-dragino2-si3217x_3.10.49+0.2-1_ar71xx.ipk --force-depends
```

14.2 How to recover the LG02 if firmware crash

LG02 provide user a full control on its Linux system, it is possible that the device will brick and can't boot after improper modification in some booting files.

In this case, user can recover the whole Linux system by uploading a new firmware via Web Failsafe mode.

Procedure is as below:

1. Use a RJ45 cable to connect the PC to LG02's port directly.
2. Set the PC to ip 192.168.255.x, netmask 255.255.255.0
3. Pressing the toggle button and power on the device
4. All LEDs of the device will blink, release the toggle button after four blinks
5. All LEDs will then blink very fast once, this means device detect a network connection and enter into the web-failsafe mode. Your PC should be able to ping 192.168.255.1 after device enter this mode.
6. Open 192.168.255.1 in web browser
7. Select a squashfs-sysupgrade type firmware and update firmware.

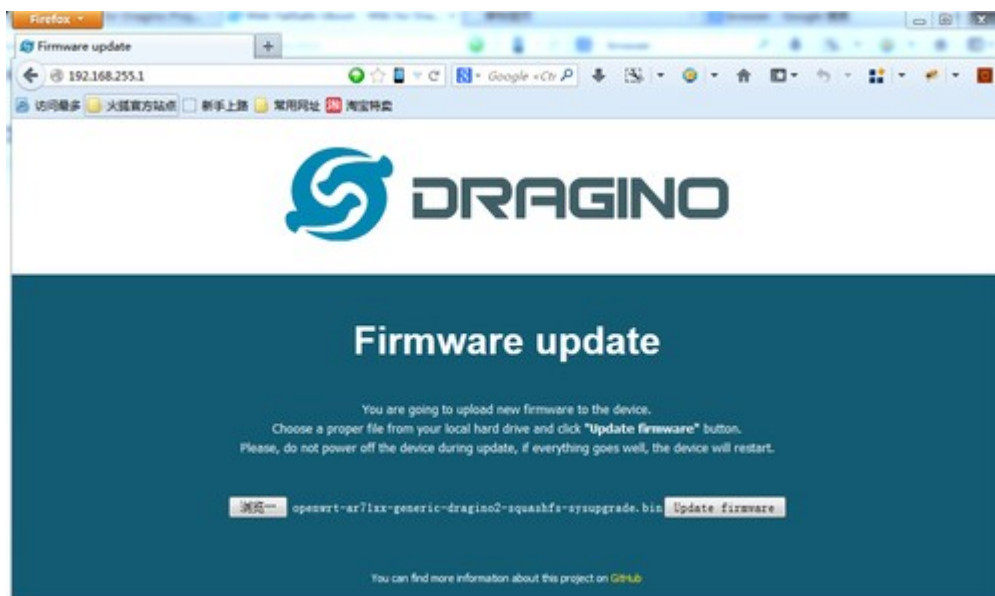

Note: If user sees all LEDs blink very fast in Step 5. This means the network connection is established. If in this case, PC still not able to see the web page, user can check:

- ✓ Try different browser.
- ✓ Check if your PC is in 192.168.255.x
- ✓ Check if you have connected two RJ45 cable to device, If so, remove the unused one

14.3 I configured LG02 for WiFi access and lost its IP. What to do now?

The LG01 has a fall-back ip in its LAN port. This IP is always enabled so user can use fall back ip to access LG01 no matter what the WiFi IP is. The fall back ip is useful for connect and debug the unit.

(Note: fallback ip can be disabled in the LAN and DHCP page)

Steps to connect via fall back IP:

1. Connect PC's Ethernet port to LG01's LAN port
2. Configure PC's Ethernet port has IP: 172.31.255.253 and netmask: 255.255.255.252

As below photo:

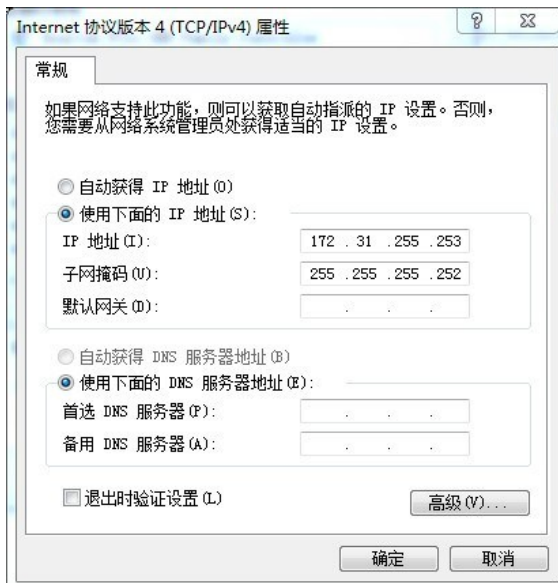

3. In PC, use 172.31.255.254 to access LG01 via Web or Console.

15. Order Info

PART:

- ✓ **Indoor version LG02-XXX-YYY**
- ✓ **Outdoor version: OLG02-XXX-YYY**

XXX: Frequency Band

- **433:** For Bands: EU433, CN470.
- **868:** For Bands: EU868, IN865.
- **915:** For Bands: US915, AU915, AS923, KR920.

YYY: 4G Cellular Option

- **EC25-E:** EMEA, Korea, Thailand, India.
- **EC25-A:** North America/ Rogers/AT&T/T-Mobile.
- **EC25-AU:** Latin America, New Zeland, Taiwan
- **EC25-J:** Japan, DOCOMO/SoftBank/ KDDI

More info about valid bands, please see [EC25-E product page](#).

16. Packing Info

Package Includes:

- ✓ LG02 or OLG02 LoRa Gateway x 1
- ✓ Stick Antenna for LoRa RF part. Frequency is one of 433 or 868 or 915Mhz depends the model ordered
- ✓ Power Adapter: EU/AU/US type power adapter depends on country to be used
- ✓ Packaging with environmental protection paper box

Dimension and weight:

- ✓ Device Size: 12 x 8.5 x 3 cm
- ✓ Device Weight: 150g
- ✓ Package Size / pcs : 21.5 x 10 x 5 cm
- ✓ Weight / pcs : 360g
- ✓ Carton dimension: 45 x 31 x 34 cm. 36pcs per carton
- ✓ Weight / carton : 12.5 kg

17. Support

- Try to see if your questions already answered in the [wiki](#).
- Support is provided Monday to Friday, from 09:00 to 18:00 GMT+8. Due to different timezones we cannot offer live support. However, your questions will be answered as soon as possible in the before-mentioned schedule.

- Provide as much information as possible regarding your enquiry (product models, accurately describe your problem and steps to replicate it etc) and send a mail to

support@dragino.com

18. Reference

- ✧ Source code for LG02 LoRa Gateway
https://github.com/dragino/openwrt_lede-18.06

- ✧ OpenWrt official Wiki
<http://www.openwrt.org/>

- ✧ Download of this manual or Update version
http://www.dragino.com/downloads/index.php?dir=UserManual/LG02_OLG02/

- ✧ LMIC library for Arduino LoRaWAN end device use with LG02.
<https://github.com/dragino/arduino-lmic>

- ✧ Hardware Source
LG02 = [IBB](#) + [LoRa G Dual](#)
OLG02= [PAN v2.0](#) + [LoRa G Dual](#)